

CHAINS

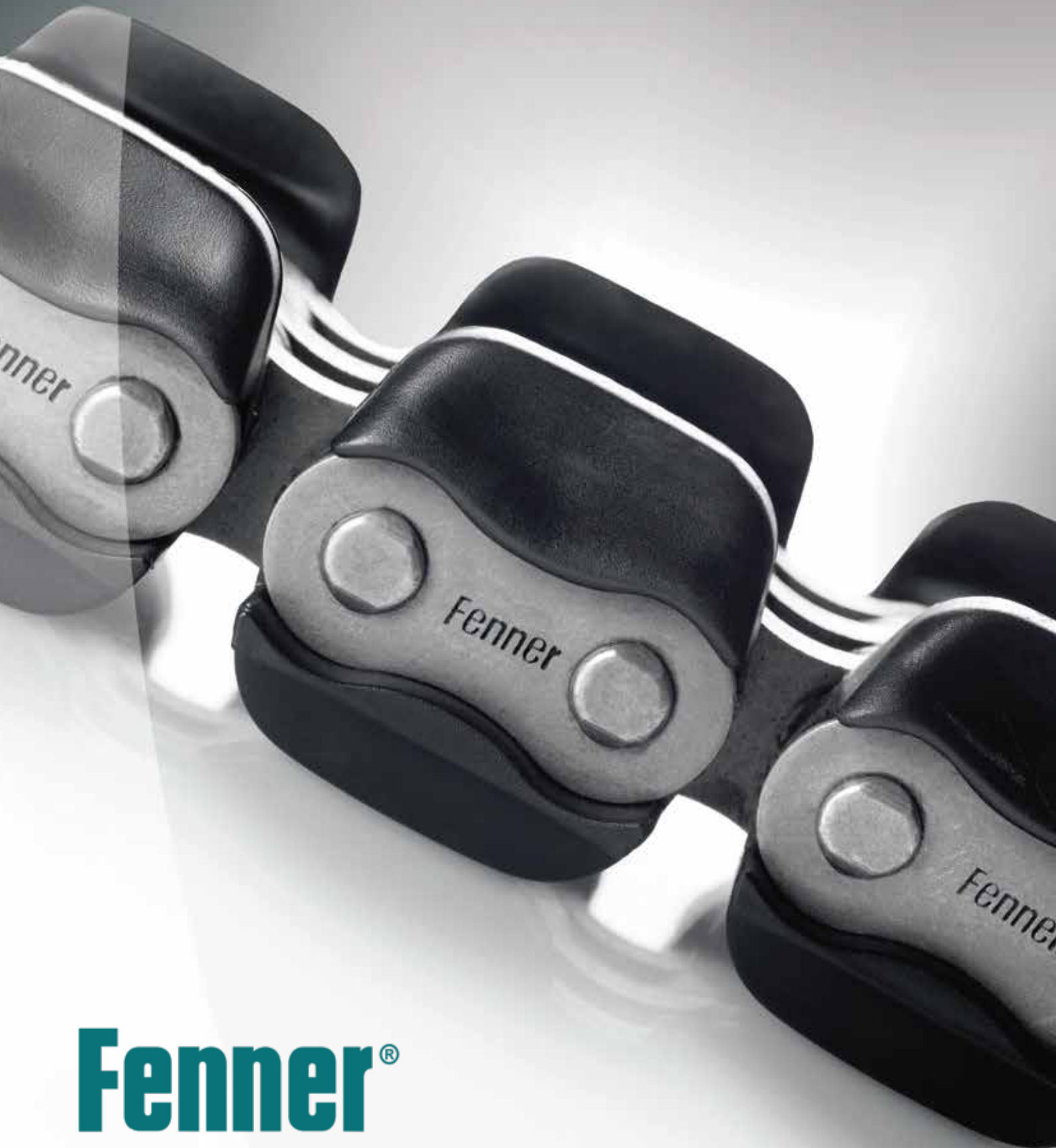

Fenner® Lifting Chains



Fenner®

Reliable | Trusted | Connected



Exceptional Performance

Fenner power transmission products are world renowned for delivering the ultimate combination of rugged construction, reliable and efficient performance and value for money - proven in the harshest environments, guaranteed to perform in yours!

All power transmission products are manufactured to exacting specifications in line with international standards, and are backed-up by a product development programme designed to keep them at the cutting edge.

Over 150 Years of Engineering Heritage

Fenner has been a leading name in power transmission for over 150 years and generations of professional engineers have placed their trust in these products.

Founded in 1861 by Joseph Henry Fenner, the company started as a manufacturer of horse hair and leather power transmission belts. In 1921, woven textile belts were developed and the company began to produce some of the finest transmission belting in the market. Today, Fenner product range include transmission belts, pulleys, chains, sprockets, couplings, taper lock bushes, shaft fixings, gearboxes, motors and inverters.

Our success in the market means that today the Fenner mark is widely recognised as synonymous with exceptional products for everyday use - a fitting tribute to the designers and engineers who proudly continue to oversee these ever-improving fundamentals of power transmission.



Fenner Guarantee



Products are guaranteed in terms of the manufacturer's Standard Conditions of Business only if all components of an assembly (excluding belts) are of genuine manufacture

All products in this manual are available for purchase subject to our standard conditions of sale. To the best of our knowledge the representations concerning performance of any items contained in this manual are, at date of publication, accurate within normally accepted tolerances. We shall not, however, be liable for consequences arising from inaccuracies in drawings, specification or other information based on specifications, dimensions, calculations or information of whatsoever nature obtained from this manual nor be bounded thereto.

All products covered by this manual are manufactured to standards and or specifications adequate for the purpose for which they have been designed. We will repair, or at our discretion, replace, free of charge at point of delivery, any item or part thereof which may prove, within three months after delivery, to be defective due to faulty workmanship or material, save as aforesaid, no warranty or misrepresentation of any nature is or shall be taken to be given by us or is or can be implied.

The information contained herein is subject to alteration without notice, and accordingly, we shall not be bound to the contents of the terms hereof.

IMPORTANT NOTE:

All products listed in this manual are not approved for use in aviation industries. This comprehensive range is suitable for general industrial purposes.



Reliable.
Trusted.
Connected.



Fenner's worldwide commitment to quality is a guarantee that wherever the project or customer is located, the Fenner products supplied will always meet the most exacting standards.

Complete Drive Solution for You



The complete drive solution from prime mover to driven machine in one range with one result - driven performance.



Table of Contents

Items	Page
FENNER LIFTING CHAINS	
Leaf Chains LH series	1-2
Leaf Chains LL series	3-4
Leaf Chains AL series	5
Standard Leaf Chains	6-10
Special Leaf Chains	11-13
Special Leaf Chains for Sky Stacker	14-15
Multiple Plate Bearing Pin Chains	16-17
Car Parking Chains	18
Rollerless Hoisting Chains	19
Special Leaf Chains with Plastic Guides	20-24
Connecting Pins for Leaf Chains LL series	25
Connecting Pins for Leaf Chains BL series	26-27
Connecting Pins for Leaf Chains AL series	28
Plate Lacing	29
Measurements for Anchors	29
Connecting End Plates for Leaf Chains	30



Fenner® Leaf Chains LH series

ANSI BL series ISO DIN 8152

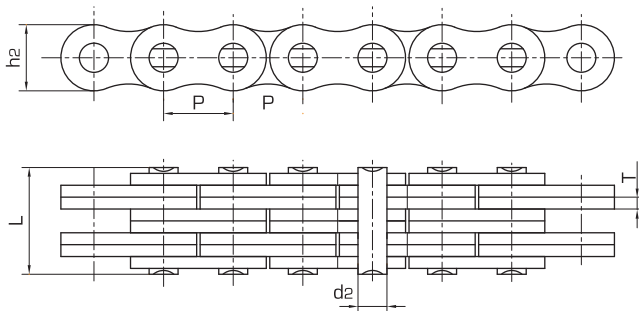
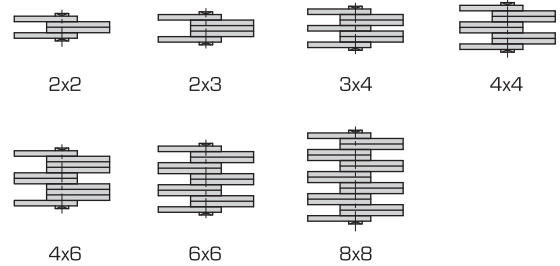

Plate lacing



ISO Chain No.	ANSI Chain No.	Pitch	Plate lacing	Plate depth h ₂ max mm	Plate thickness T max mm	Pin diameter d ₂ max mm	Pin length L max mm	Ultimate tensile strength	Average tensile strength	Weight per meter q kg/m
		P mm						Q min kN/lbf	Q ₀ kN	
LH0822	BL422	12.7	2 x 2	12.07	2.08	5.09	11.05	22.2/5045	27.6	0.64
LH0823	BL423		2 x 3				13.16	22.2/5045	27.6	0.80
LH0834	BL434		3 x 4				17.40	33.4/7591	41.4	1.12
LH0844	BL444		4 x 4				19.51	44.5/10114	56.0	1.28
LH0846	BL446		4 x 6				23.75	44.5/10114	56.0	1.60
LH0866	BL466		6 x 6				27.99	66.7/15159	81.7	1.92
LH0888	BL488		8 x 8				36.45	89.0/20227	109.4	2.56
LH1022	BL522		15.875				2 x 2	15.09	2.44	5.96
LH1023	BL523	2 x 3		15.37	33.4/7591	43.1	1.15			
LH1034	BL534	3 x 4		20.32	48.9/11114	65.6	1.63			
LH1044	BL544	4 x 4		22.78	66.7/15159	84.5	1.80			
LH1046	BL546	4 x 6		27.74	66.7/15159	84.5	2.27			
LH1066	BL566	6 x 6		32.69	100.1/22750	125.1	2.70			
LH1088	BL588	8 x 8		42.57	133.4/30318	169.5	3.60			
LH1222	BL622	19.05		2 x 2	18.11	3.30	7.94			
LH1223	BL623		2 x 3	20.73				48.9/11114	63.6	1.93
LH1234	BL634		3 x 4	27.43				75.6/17181	102.8	2.67
LH1244	BL644		4 x 4	30.78				97.9/22250	120.9	3.04
LH1246	BL646		4 x 6	37.49				97.9/22250	120.9	3.79
LH1266	BL666		6 x 6	44.20				146.8/33364	190.8	4.53
LH1288	BL688		8 x 8	57.61				195.7/44477	238.8	6.02
LH1622	BL822		25.4	2 x 2				24.13	4.09	9.54
LH1623	BL823	2 x 3		25.48	84.5/19204	108.2	3.15			
LH1634	BL834	3 x 4		33.76	129.0/29318	170.0	4.37			
LH1644	BL844	4 x 4		37.90	169.0/38409	214.6	4.98			
LH1646	BL846	4 x 6		46.18	169.0/38409	214.6	6.20			
LH1666	BL866	6 x 6		54.46	253.6/57636	324.5	7.42			
LH1688	BL888	8 x 8		71.02	338.1/76841	432.7	9.80			



Fenner® Leaf Chains LH series

ANSI BL series ISO DIN 8152

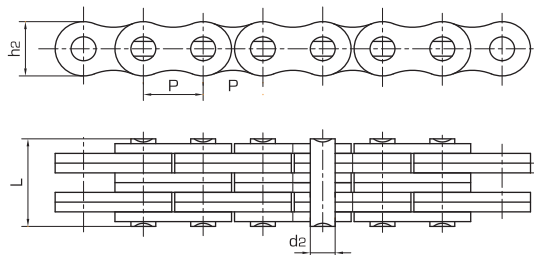
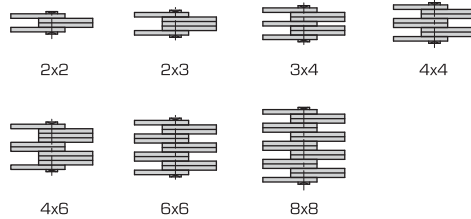

Plate lacing



ISO Chain No.	ANSI Chain No.	Pitch P mm	Plate lacing	Plate depth h ₂ max mm	Plate thickness T max mm	Pin diameter d ₂ max mm	Pin length L max mm	Ultimate tensile strength	Average tensile strength	Weight per meter
								Q min kN/lbf	Q ₀ kN	q kg/m
LH2022	BL1022	31.75		30.18	4.9	11.11	25.37	115.6/26272	150.8	3.60/3.75
LH2023	BL1023						30.33	115.6/26272	150.8	4.47/4.65
LH2034	BL1034						40.23	182.4/41454	231.6	6.22/6.45
LH2044	BL1044						45.19	231.3/52568	291.4	7.08/7.37
LH2046	BL1046						55.09	231.3/52568	291.4	8.85/9.18
LH2066	BL1066						65.00	347.0/78863	430.3	10.41/10.99
LH2088	BL1088						84.81	462.6/105136	555.1	14.03/14.58
LH2422	BL1222	38.1		36.20	5.77	12.71	29.62	151.2/34363	192.0	5.35
LH2423	BL1223						35.43	151.2/34363	192.0	6.64
LH2434	BL1234						47.07	244.6/55591	315.9	9.23
LH2444	BL1244						52.88	302.5/68750	381.1	10.55
LH2446	BL1246						64.52	302.5/68750	381.1	13.12
LH2466	BL1266						76.15	453.7/103113	543.6	15.74
LH2488	BL1288						99.42	605.0/137500	726.0	20.89
LH2822	BL1422	44.45		42.24	6.55	14.29	33.55	191.1/43477	225.7	7.31
LH2823	BL1423						40.16	191.3/43477	225.7	9.09
LH2834	BL1434						53.37	315.8/71772	372.6	12.65
LH2844	BL1444						59.97	382.6/86954	451.2	14.44
LH2846	BL1446						73.18	382.6/86954	451.2	17.9
LH2866	BL1466						86.39	578.3/131431	682.4	21.56
LH2888	BL1488						112.8	765.1/173886	902.8	28.84
LH3222	BL1622	50.8		48.26	7.52	17.46	39.01	289.1/65704	341.1	9.64
LH3223	BL1623						46.58	289.1/65704	341.1	11.4
LH3234	BL1634						61.72	440.4/100091	519.6	15.75
LH3244	BL1644						69.29	573.8/131431	680.4	18.0
LH3246	BL1646						84.43	578.3/131431	680.4	22.47
LH3266	BL1666						99.57	857.4/194863	1000.7	27.02
LH3288	BL1688						129.84	1156.5/262841	1364.6	35.93
LH4022	BL2022	63.5		60.33	9.91	23.81	51.74	433.7/98568	511.7	15.8
LH4023	BL2023						61.70	433.7/98568	511.7	19.8
LH4034	BL2034						81.61	649.4/147590	766.2	27.7
LH4044	BL2044						91.57	867.4/197163	1023.5	31.6
LH4046	BL2046						111.48	867.4/197163	1023.5	39.5
LH4066	BL2066						131.39	1301.1/295704	1535.2	47.4
LH4088	BL2088						171.22	1734.8/394272	2046.5	63.2



Fenner® Leaf Chains LL series

DIN 8152 ISO 4347

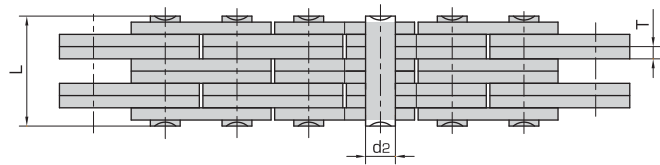
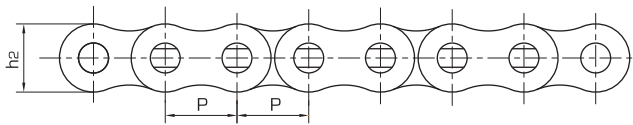
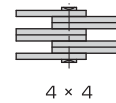
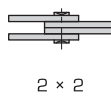

Plate lacing



ISO Chain No.	Pitch	Plate lacing	Plate depth h ₂ max mm	Plate thickness T max mm	Pin diameter d ₂ max mm	Pin length L max mm	Ultimate tensile strength	Average tensile strength	Weight per meter
	P mm						Q min kN/lbf	Q ₀ kN	q kg/m
LL0822	12.7	2 x 2	10.6	1.6	4.45	8.9	18.2/4094	20.4	0.42
LL0844		4 x 4				15.6	36.4/8188	40.7	0.84
LL0866		6 x 6				22.0	54.6/12283	60.0	1.24
LL0888		8 x 8				28.5	72.8/16378	80.0	1.64
LL1022	15.875	2 x 2	13.7	1.6	5.08	9.2	22.7/5107	25.5	0.54
LL1044		4 x 4				15.8	45.4/10213	51.0	1.06
LL1066		6 x 6				22.1	68.1/15321	76.3	1.57
LL1088		8 x 8				28.8	90.8/20427	101.9	2.10
LL1222	19.05	2 x 2	16.0	1.85	5.72	10.4	29.5/6637	33.2	0.73
LL1244		4 x 4				17.9	59.0/13273	66.4	1.44
LL1266		6 x 6				25.4	88.5/19910	99.7	2.15
LL1288		8 x 8				32.9	118.0/26547	132.9	2.84



Fenner® Leaf Chains LL series

ISO 4347 DIN 8152

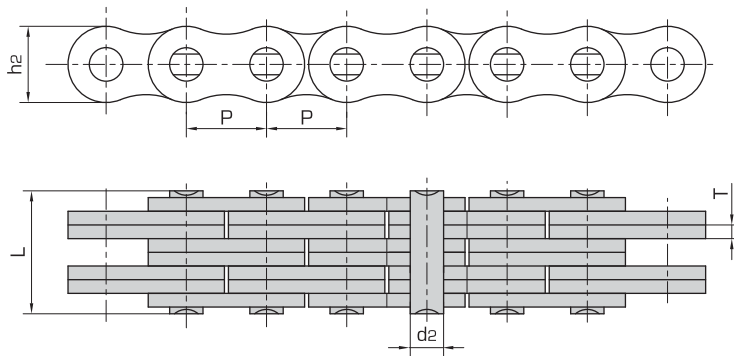
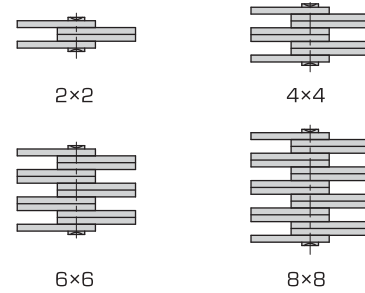

Plate lacing



DIN/ISO Chain No.	Pitch P mm	Plate lacing	Plate depth h_2 max mm	Plate thickness T max mm	Pin diameter d_2 max mm	Pin length L max mm	Ultimate tensile strength Q_{min} kN/lbf	Average tensile strength Q_0 kN	Weight per meter q kg/m
LL1622	25.4	2 x 2	21.00	3.1	8.28	17.2	58.0/13182	66.7	1.65
LL1644		4 x 4				29.6	116.0/26363	140.0	3.23
LL1666		6 x 6				42.4	174.0/39545	208.8	4.81
LL1688		8 x 8				54.9	232.0/52726	278.0	6.40
LL2022	31.75	2 x 2	26.40	3.5	14.63	20.1	95.0/21591	109.2	2.33
LL2044		4 x 4				33.8	190.0/43182	218.5	4.40
LL2066		6 x 6				50.1	285.0/64773	324.6	6.79
LL2088		8 x 8				64.0	380.0/86363	435.1	8.9
LL2422	38.1	2 x 2	33.40	5.0	14.63	28.4	170.0/38363	195.5	4.47
LL2444		4 x 4				46.3	340.0/77273	380.8	8.22
LL2466		6 x 6				66.4	510.0/115909	571.2	12.22
LL2488		8 x 8				86.6	680.0/154545	775.2	16.30
LL2822	44.45	2 x 2	37.08	6.0	15.90	32.2	200.0/45455	224.0	5.65
LL2844		4 x 4				56.4	400.0/90909	448.0	10.84
LL2866		6 x 6				80.8	600.0/136363	672.0	16.15
LL2888		8 x 8				105.2	800.0/181818	896.0	21.85
LL3222	50.8	2 x 2	42.00	17.81	17.81	34.8	260.0/59091	291.2	6.85
LL3244		4 x 4				60.6	520.0/118182	582.4	13.35
LL3266		6 x 6				86.4	780.0/177272	873.6	19.60
LL3288		8 x 8				112.2	1040.0/233970	1176.0	26.35
LL4022	63.5	2 x 2	52.76	8.0	22.89	42.2	360.0/81818	403.2	10.84
LL4044		4 x 4				74.4	780.0/177273	873.6	21.13
LL4066		6 x 6				106.5	1080.0/245454	1209.6	31.29
LL4088		8 x 8				140.0	1440.0/323959	1747.2	41.79
LL4822	76.2	2 x 2	63.88	10.0	29.24	54.6	560.0/127272	627.2	18.50
LL4844		4 x 4				92.6	1120.0/254545	1554.4	35.70
LL4866		6 x 6				133.4	1680.0/377953	1880.0	53.00
LL4888		8 x 8				174.2	2240.0/509091	2508.8	70.40



Fenner® Leaf Chains AL series

ANSI B 29.8 - 1958 AL norm

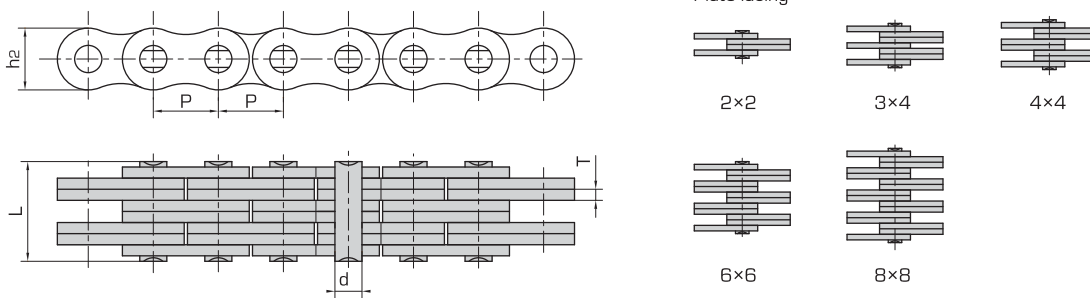

ANSI Chain No.	Pitch P mm	Plate lacing	Plate depth h ₂ max mm	Plate thickness T max mm	Pin diameter d ₂ max mm	Pin length L max mm	Ultimate tensile strength Q ₀ min kN/lbf	Average tensile strength Q ₀ kN	Weight per meter q kg/m
AL322	9.525	2 x 2	7.7	1.30	3.58	6.80	9.0/2045	10.2	0.23
AL344		4 x 4				11.60	18.0/4090	20.0	0.46
AL422	12.7	2 x 2	10.4	1.50	3.96	8.30	14.7/3304	15.4	0.39
AL444		4 x 4				14.40	29.4/6609	30.8	0.74
AL466		6 x 6				20.50	44.0/9891	46.2	1.13
AL522	15.875	2 x 2	12.8	2.03	5.08	11.05	24.5/5508	25.2	0.64
AL534		3 x 4				17.00	36.8/8273	37.8	1.10
AL544		4 x 4				19.40	48.9/10993	50.5	1.25
AL566		6 x 6				27.50	73.4/16500	74.2	1.79
AL622	19.05	2 x 2	15.6	2.42	5.94	13.00	33.4/7508	37.5	0.86
AL644		4 x 4				22.70	66.7/14994	75.0	1.76
AL666		6 x 6				32.20	100.1/22502	112.5	2.60
AL688		8 x 8				42.20	133.4/29988	142.0	3.49
AL822	25.4	2 x 2	20.8	3.25	7.92	16.20	57.9/13016	65.0	1.64
AL844		4 x 4				29.40	115.7/26009	130.0	3.24
AL866		6 x 6				44.20	173.5/39003	195.0	4.83
AL888		8 x 8				55.50	231.4/52019	245.0	6.43
AL1022	31.75	2 x 2	25.6	4.00	9.53	19.60	84.5/18996	98.0	2.37
AL1044		4 x 4				36.40	169.0/37991	196.0	4.68
AL1066		6 x 6				52.30	253.3/56987	294.0	7.20
AL1088		8 x 8				68.50	338.0/75982	371.0	9.94
AL1222	38.1	2 x 2	30.5	4.80	11.10	24.30	120.1/26998	136.0	3.65
AL1244		4 x 4				43.80	240.2/53997	272.0	7.05
AL1266		6 x 6				63.20	360.3/80995	394.0	10.50
AL1288		8 x 8				82.60	480.4/107994	512.0	14.03
AL1444	44.45	4 x 4	36.4		12.64	51.30	302.5/68002	356.0	10.34
AL1466		6 x 6				74.50	453.7/101992	534.0	15.16
AL1644	50.8	4 x 4	41.6	6.40	14.21	58.00	382.5/85986	449.6	12.98
AL1666		6 x 6				83.80	573.8/128990	674.4	19.76
AL1688		8 x 8				109.50	765.0/171972	899.2	25.47



Fenner® Standard Leaf Chains

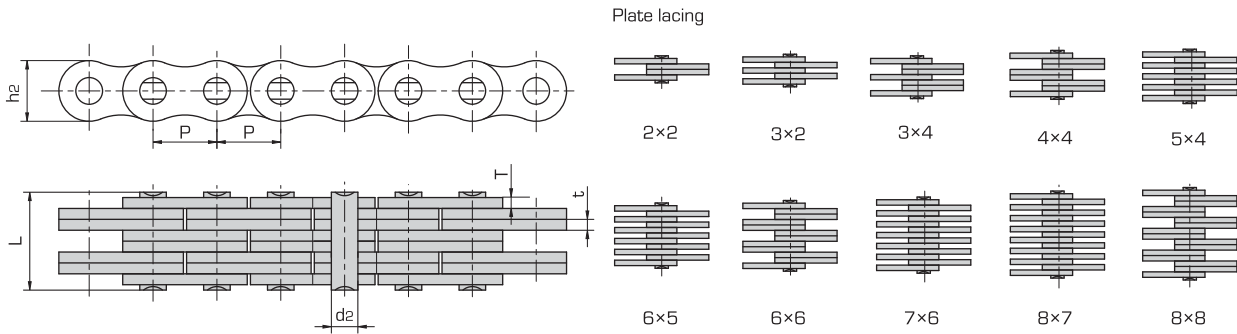

Chain No.	Pitch P mm	Plate lacing	Plate depth h ₂ max mm	Plate thickness T max mm	Pin diameter d ₂ max mm	Pin length L max mm	Ultimate tensile strength Q _{min} kN/lbf	Average tensile strength Q ₀ kN	Weight per meter q kg/m
FL644		4 x 4				6.6	6.5/1477	7.8	0.13
FL666	5.94	6 x 6	4.7	0.60	1.85	9.3	9.75/2216	11.8	0.20
FL688		8 x 8				12.0	13.0/2955	15.6	0.25
FL523	8.0	3 x 2	6.3	1.00	2.31	6.7	7.0/1575	7.4	0.18
*FL523F1	8.0	3 x 2	6.3	1.30/1.00	2.31	6.3	7.0/1575	7.4	0.25
*FL523F3	8.0	3 x 2	7.6	1.30/1.04	3.10	8.0	7.0/1575	8.0	0.33
*FL523F4	8.0	3 x 2	7.6	1.30/1.04	2.31	7.6	7.0/1576	8.0	0.32
FL844	8.0	4 x 4	6.9	0.73	2.31	7.9	10.0/2273	12.1	0.25
*FL823F1	8.0	3 x 2	7.6	1.30/1.04	3.15	7.8	11.0/2472	11.8	0.32
FL922		2 x 2				6.2	10.0/2273	12.1	0.22
FL944		4 x 4				10.4	21.0/4724	24.7	0.43
FL945		4 x 5				11.5	21.0/4724	23.0	0.50
FL956	9.525	6 x 5	8.7	1.04	3.28	14.0	25.5/5732	28.0	0.60
FL966		6 x 6				14.9	31.0/7045	36.8	0.65
FL988		8 x 8				19.0	42.00/9450	46.2	0.87
FL966F3	9.525	6 x 6	8.7	1.15	3.28	16.2	33.1/7441	36.5	0.75
FL922F4	9.525	2 x 2	8.5	1.60	3.90	8.6	12.5/2810	13.8	0.37
LF10	10.0	3 x 3	7.5	1.20	3.20	10.6	14.0/3150	15.5	0.39
LF1234	12.0	4 x 3	10.0	2.03	3.96	17.6	15.45/3476	17.0	0.85
LF1246	12.0	Δ 6 x 4	10.8	1.60	5.08	18.7	30.0/6748	33.0	1.05
F1266F1	12.7	Δ 6 x 6	9.0	1.60	3.70	21.6	45.0/10123	50.0	0.92
F122	12.7	2 x 2	8.2	1.00	3.58	7.0	11.43/2598	13.6	0.19
F1223	12.7	3 x 2	10.2	2.03	4.45	12.8	20.0/4545	23.8	0.61
FL1244	12.7	4 x 4	10.2	1.70	4.45	16.7	44.0/10000	52.3	0.83
F1023	15.875	3 x 2	14.3	2.42	4.75	15.9	25.00/5625	27.5	1.11
FLC534		3 x 4				15.3	40.4/9181	44.4	0.99
FLC545	15.875	5 x 4	12.7	1.85	5.08	19.2	54.3/12340	59.7	1.27
FLC556		6 x 5				22.7	67.6/15363	74.3	1.54
FLC567		7 x 6				26.8	80.80/18176	89.0	1.82



Fenner® Standard Leaf Chains

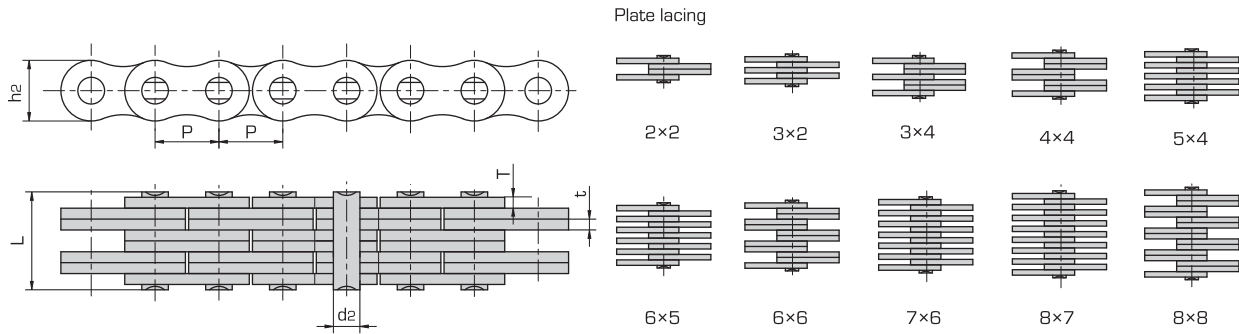

Chain No.	Pitch P mm	Plate lacing	Plate depth he max mm	Plate thickness T max mm	Pin diameter d2 max mm	Pin length L max mm	Ultimate tensile strength Q min kN/lbf	Average tensile strength Q0 kN	Weight per meter q kg/m
FLC578	15.875	8 x 7	12.70	1.85	5.08	30.8	90.0/20250	99.0	2.10
CTL566	15.875	6 x 6	15.10	2.10	5.08	28.0	78.0/17534	86.0	2.44
CTBLL588	15.875	8 x 8	14.80	1.70	5.94	30.7	85.0/19108	105.0	2.59
*CH25	17.0	2 x 1	9.00	1.60	4.00	7.5	6.0/1348	7.5	0.27
LF1866	18.55								3.58
LF1966	19.05	6 x 6	15.80	3.00	6.00	3.9	106.0/23845	116.6	3.53
F19S-44	19.05	4 x 4	14.70	2.25	5.98	21.8	76.50/17210	84.5	1.55
F19S-66		6 x 6				31.0	115.0/25870	126.5	2.31
F19V-44	19.05	4 x 4	15.20	2.42	6.50	22.4	71.0/16136	84.3	1.73
F19V-66		6 x 6				32.3	106.0/24090	125.9	2.57
FLC823		3 x 2				20.9	65.0/14612	72.0	1.86
FLC834		4 x 3				27.4	100.0/22500	110.0	2.57
FLC845	25.4	5 x 4	19.46	3.25	8.28	34.2	130.0/29224	143.0	3.30
FLC856		6 x 5				40.5	166.0/37343	183.0	4.00
FLC867		7 x 6				47.0	195.70/44024	215.3	4.70
FLC878		8 x 7				53.6	227.50/51180	250.5	5.40
F25-34	25.4	3 x 4	23.40	3.05/4.00	10.85	28.6	125.00/28120	137.5	3.64
F25-66		6 x 6				44.1	250.00/56240	275.0	5.93
F25-66F1	25.0	6 x 6	24.00	3.00	10.85	42.0	147.0/33046	190.0	5.65
FLC1034		4 x 3				28.4	82.7/18591	91.0	3.52
FLC1045		5 x 4				34.3	110.00/24745	121.0	4.49
FLC1056	31.75	6 x 5	25.40	3.25	9.53	40.6	137.9/31340	151.0	5.44
FLC1067		7 x 6				47.2	165.4/37590	181.9	6.42
FLC1078		8 x 7				53.8	193.0/43863	212.0	7.40
LF31109	31.75	10 x 9	27.00	4.00	12.00	83.0	440.0/98915	500.0	12.70
P35-44	35.0	Δ 4 x 4	30.00	4.00	12.00	37.7	100.0/22500	110.0	5.96
D90F1	90.0	8 x 8	70.00	6.30	36.00	113.0	980.0/220460	1078.0	41.20
LF105	105.0	11 x 10	80.00	6.00	40.00	143.0	1470.0/330690	1690.5	64.38



Fenner® Standard Leaf Chains

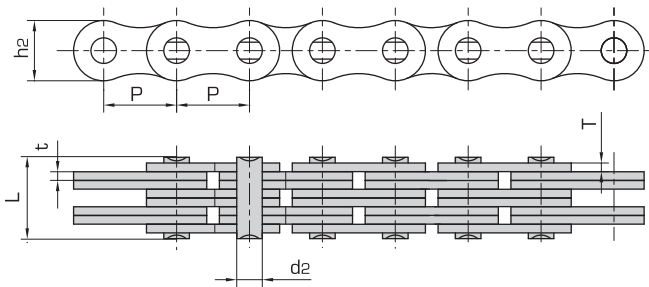
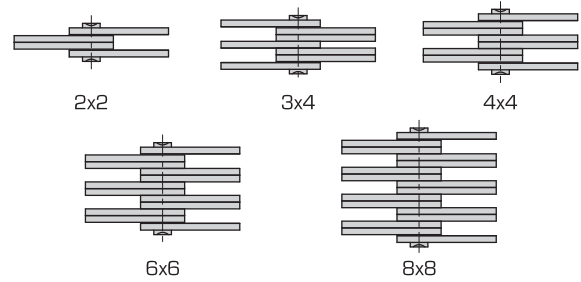

Plate lacing



Chain No.	Pitch P mm	Plate lacing	Plate depth h ₂ max mm	Plate thickness T max mm	Pin diameter d ₂ max mm	Pin length L max mm	Ultimate tensile strength Q _{min} kN/lbf	Average tensile strength Q ₀ kN	Weight per meter q kg/m
AL0522	8.0	2 x 2	7.10	0.80	2.31	5.00	4.4/990	4.6	0.15
AL0544		4 x 4				8.20	8.8/1980	9.3	0.28
AL0566		6 x 6				11.60	13.0/2922	13.7	0.42
AL322F1	9.525	2 x 2	7.00	1.30	3.58	7.50	9.3/2092	9.8	0.22
AL344F1		4 x 4				12.80	18.5/4162	19.4	0.42
AL366F1		6 x 6				18.20	27.8/6254	29.2	0.62
AL388F1		8 x 8				23.60	37.0/8323	38.8	0.82
AL866F1	25.4	6 x 6	20.50	3.00	7.92	40.30	135.0/30370	148.5	4.40
AL822F3	25.4	2 x 2	20.80	3.25	7.92	15.90	57.9/13016	70.0	1.61
AL10910F1	31.75	10 x 9	27.00	4.00	12.00	83.00	400.0/89923	441.0	11.80
AL1066F2	31.75	6 x 6	25.60	4.00	9.53	52.20	265.0/59574	305.0	7.43
AL1266F1	38.1	6 x 6	30.00	4.80	13.30	64.30	420.0/94482	462.0	9.68
BL432F1	12.7	3 x 2	11.60	2.03	4.45	12.60	22.0/4946	24.0	0.76
LH0844F5	12.7	4 x 4	12.07	1.60	5.08	16.00	27.5/6182	30.0	1.01
LH0832F6	12.7	3 x 2	12.07	2.03	4.45	13.16	19.8/4451	23.0	0.77
LH081010F8	12.7	10 x 10	12.07	2.03	5.94	44.80	120.0/26977	130.0	6.35
LH0844F	12.7	4 x 4	12.07	1.60	5.08	15.70	44.48/10000	48.9	1.01
BL544F1	15.875	4 x 4	14.60	2.37	5.94	22.50	80.0/17985	85.0	1.76
LH1034F2	15.875	3 x 4	15.00	2.42	5.94	20.30	65.0/14612	70.0	1.64
BL544F8	15.875	4 x 4	15.00	1.70	5.80	17.00	46.0/10341	53.0	1.33
LH1223F1	19.05	2 x 3	15.60	2.42	5.94	20.30	29.4/6610	32.5	1.50
LH1245F1		4 x 5				25.20	39.2/8812	43.0	1.91
LH1223F3	19.05	2 x 3	18.10	3.25	7.93	19.90	68.65/15433	71.0	1.95
LH1234F3		3 x 4				26.60	102.97/23148	108.8	2.69
*BL666GL	19.05	6 x 6	16.00	3.00	6.25	40.00	100.0/22480	110.0	3.80
BL866F1	25.4	6 x 6	24.10	3.10/4.00	10.85	45.70	200.0/44992	220.0	6.14
BL834F2		3 x 4				29.50	120.0/26995	132.0	3.76
BL834F3	25.4	3 x 4	24.10	4.00	10.90	32.90	142.0/31944	156.2	4.44
BL866F3		6 x 6				52.20	253.6/57050	279.0	7.48
BL834F5	25.4	3 x 4	24.1	3.10/4.00	10.90	28.00	120.0/26995	132.0	3.64
BL866F5	25.4	6 x 6	24.10	3.30/4.00	10.90	45.30	200.0/44992	220.0	4.94



Fenner® Standard Leaf Chains

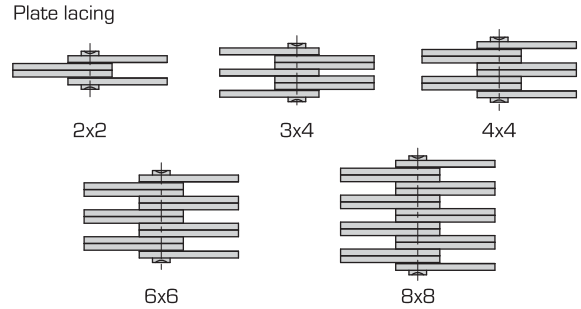
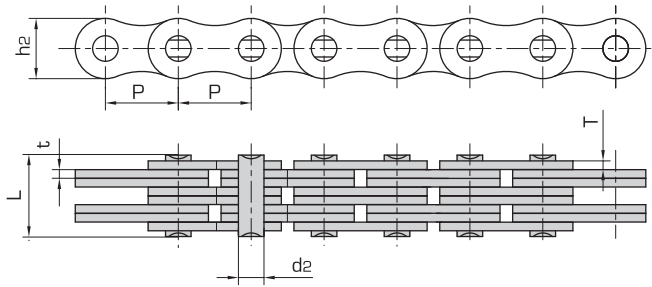

Chain No.	Pitch P mm	Plate lacing	Plate depth h ₂ max mm	Plate thickness T max mm	Pin diameter d ₂ max mm	Pin length L max mm	Ultimate tensile strength Q ₀ min kN/lbf	Average tensile strength Q ₀ kN	Weight per meter q kg/m
LH1646F3	25.4	4 x 6	24.10	4.00	9.53	44.20	233.0/52378	256.5	6.22
BL844F8	25.4	4 x 4	25.10	3.00	10.90	30.00	120.0/26976	135.0	3.84
LH2066F1	31.75	6 x 6	29.70	4.09	11.10	55.70	303.0/68177	365.0	9.42
BL1046F2	31.75	4 x 6	29.70	4.00	11.10	47.00	231.3/51996	266.0	7.74
LH2054F4	31.75	5 x 4	29.70	5.60	11.10	56.50	280.0/62947	340.0	9.56
LH281010F1	44.45	10 x 10	36.10	5.00	14.27	108.00	1220.0/274256	1400.0	22.20
LH3288F1	50.8	8 x 8	47.80	6.90	20.20	122.00	1200.0/269950	1320.0	33.53
LH3266F2	50.8	6 x 6	48.20	7.00	17.46	91.80	867.0/195040	953.7	24.52
LH3244F6	50.8	4 x 4	42.00	6.00	17.46	56.00	430.0/96667	505.0	11.96
LL0622F4	9.525	2 x 2	8.40	1.04	3.28	6.20	10.0/2248	10.5	0.23
LL0634F4		3 x 4				9.70	15.5/3484	16.5	0.39
LL0644F4		4 x 4				10.70	21.0/4720	22.0	0.44
LL0666F4		6 x 6				14.90	31.0/6970	33.0	0.65
LL0622F7	9.525	2 x 2	8.20	1.30	3.28	7.40	10.5/2360	11.6	0.27
LL0644F7		4 x 4				12.80	21.0/4720	23.0	0.52
LL0844F6	12.7	4 x 4	11.00	1.50	4.45	14.60	37.6/8452	81.4	0.82
LL0888F1		8 x 8				27.40	77.0/17310	85.0	1.61
LL0844F7	12.7	4 x 4	11.20	1.60	4.45	15.60	36.4/8180	41.5	0.85
LL0822F13	12.7	2 x 2	10.60	1.70	4.45	9.40	22.0/4940	23.0	0.45
LL0844F13		4 x 4				16.50	40.0/8990	43.0	0.88
LL101212F4	15.875	12 x 12	11.80	1.60	5.08	42.50	110.0/24728	121.0	2.47
LL101212F5	15.875	12 x 12	13.70	1.50	5.08	40.50	136.2/30620	150.0	3.00
LL1266F2	19.05	6 x 6	14.50	3.00	5.72	39.50	156.8/35249	173.0	3.03
LL1266F3	19.05	6 x 6	16.00	3.00	5.72	39.50	88.5/19895	97.5	3.03
*LL1266H	19.05	6 x 6	16.13	3.00	5.72	40.00	86.7/19490	100.0	3.75
LL1622F6	25.4	2 x 2	20.00	3.00	8.28	15.60	58.0/13047	63.8	1.40
LL2066F6	31.75	6 x 6	30.20	4.00	13.74	56.10	310.0/69690	356.5	13.13
LL3244F2	50.8	4 x 4	43.10	6.00	17.76	54.00	520.0/116978	572.0	12.62
LL3244F8	50.8	4 x 4	42.00	6.00	17.81	57.00	520.0/116900	560.0	12.31
LL3288F8		8 x 8				105.50	1040.0/233800	1125.0	24.32
LL4088F2	63.5	8 x 8	52.70	8.20	22.89	140.00	1440.0/323725	1660.0	42.39
LL4888H	76.2	8 x 8	70.00	12.00	36.50	204.0	2630.0/591639	2893.0	83.80



Fenner® Standard Leaf Chains

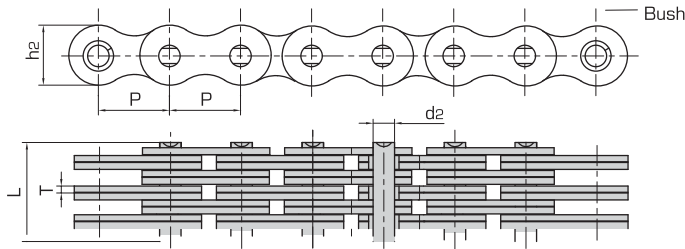

Chain No.	Bush	Pitch P mm	Plate lacing	Plate depth h ₂ max mm	Plate thickness T max mm	Pin diameter d ₂ max mm	Pin length L max mm	Ultimate tensile strength Q _{min} kN/lbf	Average tensile strength Q ₀ kN	Weight per meter q kg/m
FB156	without bush	15.875	6 x 6	14.7	1.70	5.08	24.0	78.0/17550	86.0	1.91
FB156S	with bush									
FB196	without bush	19.05	6 x 6	16.0	1.85	5.72	25.4	95.0/21371	105.0	1.94
FB196S	with bush									

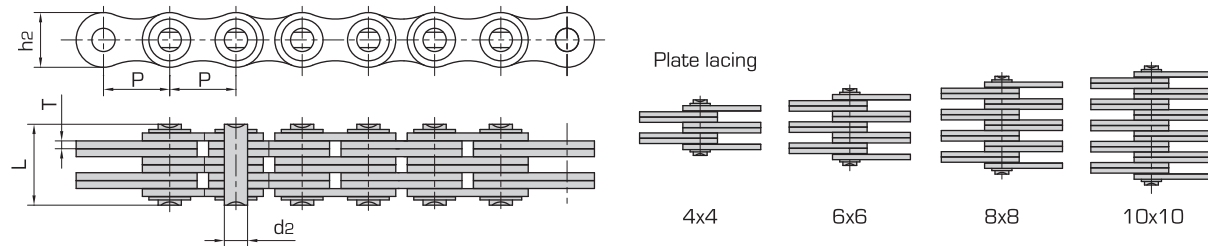

Chain No.	Pitch P mm	Plate lacing	Plate depth h ₂ max mm	Plate thickness T max mm	Pin diameter d ₂ max mm	Pin length L max mm	Ultimate tensile strength Q _{min} kN/lbf	Average tensile strength Q ₀ kN	Weight per meter q kg/m
BL1266F1	38.1	6 x 6	35.7	5.6	12.70	78.9	453.7/102063	499.0	15.69
BL1666F4	50.8	6 x 6	48.2	7.2	17.46	99.2	867.0/195040	953.7	27.27
LL2488F1	38.1	8 x 8	33.4	5.0	14.63	94.0	680.0/152864	748.0	16.71
LL3244F1	50.8	4 x 4	42.0	6.0	17.81	61.6	520.0/116978	572.0	12.90
LL3266F1		6 x 6				86.0	780.0/175467	858.0	18.90
LL3288F1		8 x 8				110.0	1040.0/233956	1144.0	24.89
LL321010F1		10 x 10				134.3	1300.0/2924445	1430.0	30.89
LL3244F3	50.8	4 x 4	43.1	6.0	17.76	60.0	520.0/116978	572.0	13.06
LL3266F3		6 x 6				84.4	780.0/175467	858.0	19.44
LL3288F3		8 x 8				108.6	1040.0/233956	1144.0	25.43
LL3244F4	50.8	4 x 4	42.0	6.4	17.81	67.5	520.0/116980	572.0	13.82
LL3266F4		6 x 6				92.8	780.0/175467	858.0	20.17
LL3288F7		8 x 8				117.0	1040.0/233800	1144.0	26.30
LL4066F1	63.5	6 x 6	57.5	6.3	19.85	100.0	1166.2/262162	1283.0	29.30
LL4088F1		8 x 8				126.0	1558.2/350283	1714.0	38.10
LL4088F3	63.5	8 x 8	57.5	6.0	19.85	119.0	1395.0/313596	1535.0	35.79
LL4044F4	63.5	4 x 4	52.7	8.0	22.89	80.8	780.0/175351	860.0	21.82
LL4888F3	76.2	8 x 8	73.0	7.2	34.67	138.5	1840.0/413632	2024.0	56.02
LL481010F3		10 x 10				165.5	2340.0/526032	2574.0	69.18



Fenner® Special Leaf Chains

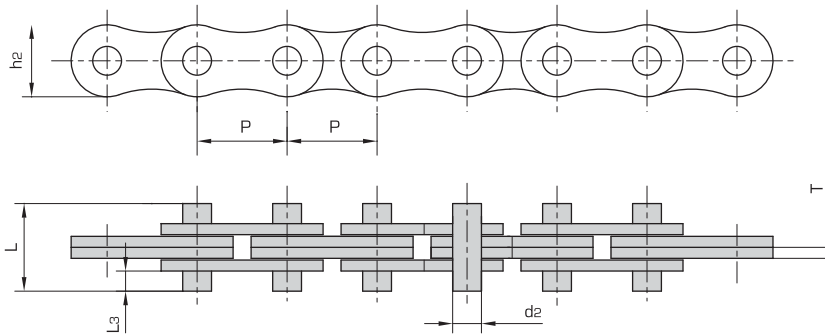

Chain No.	Pitch P mm	Plate depth h ₂ max mm	Plate thickness T max mm	Plate diameter d ₂ max mm	Pin diameter L max mm	Pin length L ₃ max mm	Ultimate tensile strength Q _{min} kN/lbf	Average tensile strength Q ₀ kN	Weight per meter q kg/m
AL422F1-D2	12.7	11.00	1.60	3.96	14.4	3.80	14.1/3172	15.5	0.50
AL522-D2	15.875	12.80	2.03	5.10	16.0	3.90	22.0/4950	23.0	0.69
AL522-D2F1					19.0	5.40			
AL522F1-D2	15.8	12.70	2.00	5.09	16.1	3.90	30.38/6834	32.0	0.66
AL622F1	19.05	16.90	3.25	5.94	22.3	4.40	50.0/11250	52.0	1.44
AL644F4-D2	19.05	14.60	3.10	5.90	22.5	4.90	36.0/8093	40.0	1.14
BL422-DD6	12.7	12.07	2.03	5.08	31.4	11.50	22.24/50000	24.5	0.91
LH1222-D2	19.05	18.10	3.25	7.92	22.6	4.60	48.93/11000	54.0	1.66
LH1222F7-DD3					29.4	8.00	48.93/11001	55.0	1.80
LH1246-DD3F1					42.5	4.75	97.9/22008	112.5	3.88
LH1622F1	25.4	24.10	4.00	9.53	34.0	8.80	84.5/19010	93.0	2.40
LH1622-D2					36.0	9.80			2.83
LH1622-DD3F1					45.0	14.30			3.04
LH1622-DD3F2					25.4	4.45			2.60
BL822F1-D2	25.4	24.10	4.60	8.80	32.4	6.80	84.5/19010	93.0	3.03
BL822HF1-D2					32.4	6.80			3.07
BL822HF2-DD3	25.4	24.00	5.00	9.53	35.0	7.05	84.5/19010	97.5	2.55
BL1022F1-D2	31.75	29.00	5.60	11.30	41.2	8.40	130.0/29245	143.0	4.49
BL1022H-D2	31.75	29.70	5.60	11.10	41.2	8.40	130.0/29245	143.0	4.69
LL1222F3-D2	19.05	14.50	2.25	5.72	22.0	6.30	44.1/9920	48.5	0.89
LL1222F5-DD3	19.05	14.50	3.00	5.72	29.0	8.30	45.1/10139	49.5	1.17
LH1222F5-DD3F1	19.05	14.50	3.00	5.72	22.0	4.80	45.1/10140	50.5	1.10
LL1622-D2	25.4	21.00	3.10	8.28	36.1	11.70	58.0/13050	64.0	1.92
LL1622F7-DD3	25.4	21.00	3.05	8.28	35.0	11.20	75.4/16950	79.2	1.85
LL1622F7-DD3F1	25.4	20.00	3.00	8.28	30.5	9.00	58.0/13040	63.8	1.65
F1422-DD3	14.29	13.00	2.03	4.97	19.1	5.20	27.50/6182	30.0	0.76
1922V-D2	19.05	16.70	3.17	6.10	22.6	4.65	55.0/12364	60.5	1.40
F2022-D2	20.75	19.00	3.40	7.65	23.0	4.50	50.0/11500	55.0	1.79
F2422-D2	23.95	22.20	3.86	8.69	27.8	5.90	60.0/13500	66.0	2.37
F2422F1-D2	24.0	22.00	4.00	9.00	27.0	5.40	60.0/13500	66.0	2.39



Fenner® Special Leaf Chains

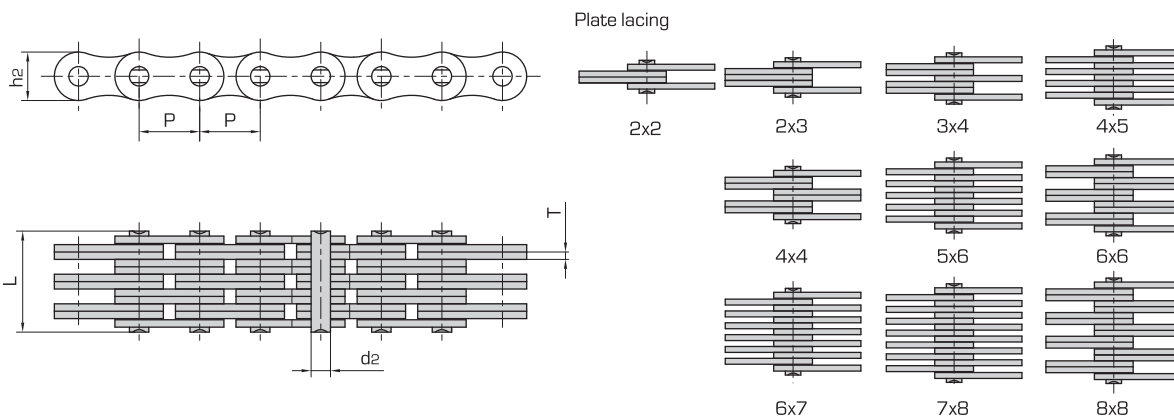

Chain No.	Pitch P mm	Plate lacing	Plate depth h ₂ max mm	Plate thickness T max mm	Pin diameter d ₂ max mm	Pin length L max mm	Chain length for 100 pitches [±0.25%] Q ₀ min kN/lbf	Ultimate tensile strength Q ₀ min kN/lbf	Weight per meter q kg/m
1234		3 x 4				14.2		31.0/6974	0.75
1256	12.7	5 x 6	10.6	1.70	4.45	21.1	1262	53.0/12045	1.17
1288		8 x 8				29.9		85.0/19318	1.70
1523		2 x 3				12.1		29.0/6590	0.75
1534		3 x 4				16.5		46.0/10454	1.04
1543		4 x 3				16.5		46.0/10455	1.05
1544		4 x 4				18.1		58.0/13181	1.18
1545	15.875	4 x 5	12.7	1.94	5.08	20.3	1580	58.0/13181	1.33
1556		5 x 6				24.0		72.0/16363	1.63
1566		6 x 6				26.2		87.0/19772	1.77
1567		6 x 7				28.0		90.0/20454	1.91
1578		7 x 8				32.5		101.0/22954	2.20
1588		8 x 8				34.0		115.0/26136	2.34
1944		4 x 4				21.3		73.0/16590	1.58
1966	19.05	6 x 6	15.0	2.29	5.72	30.7	1891	110.0/25000	2.37
1988		8 x 8				40.0		140.0/31817	3.13
2523		2 x 3				18.8		72.0/16363	1.83
2534		3 x 4				25.3		108.0/24545	2.55
2544		4 x 4				29.5		145.0/32597	2.92
2545	25.4	4 x 5	20.2	3.06	8.28	31.6	2532	144.0/30727	3.26
2556		5 x 6				37.2		180.0/40908	3.96
2567		6 x 7				43.8		216.0/490909	4.68
2578		7 x 8				50.0		252.0/57272	5.39
2588		8 x 8				52.8		290.0/65908	5.77
3144	31.75	4 x 4	22.8	4.10	10.19	37.5	3168	214.0/48109	4.24



Fenner® Special Leaf Chains

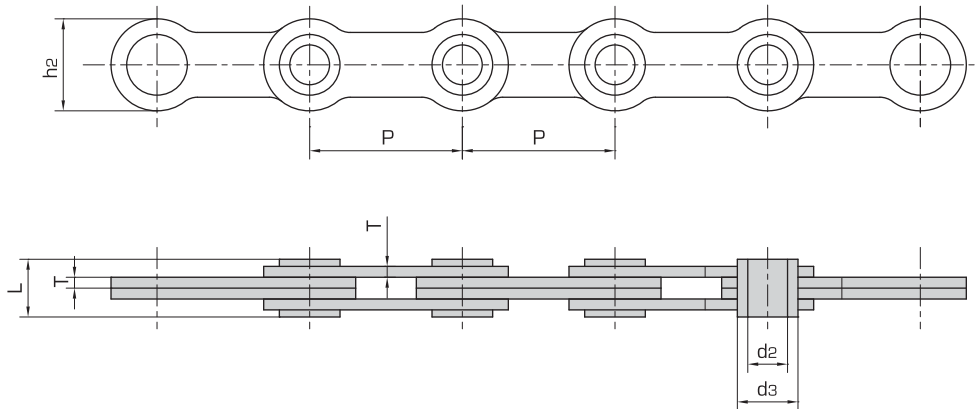

Chain No.	Pitch P mm	Plate lacing	Plate depth h2 max mm	Plate thickness T max mm	Pin diameter		Pin length L max mm	Ultimate tensile strength Q min kN/lbf	Average tensile strength Q0 kN	Weight per meter q kg/m
					d2 max mm	d3 max mm				
FL36	36.513	2 x 2	22.3	2.03	10.2	14.4	12.0	20.0/4496	25.0	0.85
FL36F2	36.513	2 x 2	24.0	2.50	9.5	14.9	15.0	30.0/6744	37.5	1.19
FL36F3	36.513	2 x 2	24.0	2.50	10.0	14.9	15.0	30.0/6744	37.5	1.16
*FL36F4	36.513	2 x 2	23.6	2.60	8.2	11.0	16.6	15.0/3372	30.0	1.25
FL36F6	36.513	2 x 2	22.0	2.60	9.5	14.5	14.5	35.0/7868	37.5	1.15
FL36F7	36.513	2 x 2	22.4	2.60	9.6	13.0	14.7	31.0/6969	40.5	1.05
FL36F8	36.513	2 x 2	23.6	2.60	10.0	13.0	16.6	15.0/3372	30.0	1.25

Note: * means straight link plate;



Fenner® Special Leaf Chains for Sky Stacker

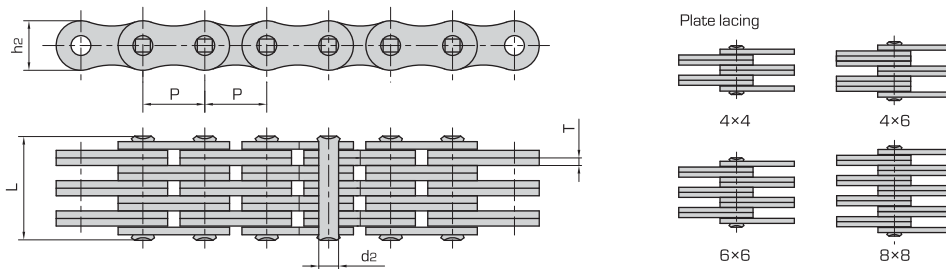

Chain No.	Pitch P mm	Plate lacing	Plate depth h2 max mm	Plate thickness T max mm	Pin diameter d2 max mm	Pin length L max mm	Ultimate tensile strength Q min kN/lbf	Average tensile strength Qo kN	Weight per meter q kg/m
LH2066(DG)	31.75	6 x 6	30.18	4.80	11.10	64.0	347.0/78008	380.0	11.65
LH2466(DG)	38.1	6 x 6	36.20	5.60	12.70	74.5	453.7/101992	475.0	11.52
LH2466F2(DG)						74.2	648.0/145670	710.0	11.52
LH2844(DG)	44.45	4 x 4	42.20	6.40	14.27	57.5	382.6/86008	400.0	14.12
LH2846(DG)		4 x 6				73.0	382.6/86009	400.0	17.63
LH2866(DG)		6 x 6				83.2	706.0/158709	810.0	21.09
LH3234(DG)	50.8	3 x 4	48.20	7.20	17.46	57.9	440.4/99002	506.0	15.49
LH3244(DG)		4 x 4				65.1	573.8/128990	602.0	17.67
LH3246(DG)		4 x 6				80.0	573.8/128990	602.0	22.20
LH3266(DG)		6 x 6				96.7	867.4/194991	911.0	26.70
LH3288(DG)		8 x 8				123.3	1156.5/259981	1214.0	35.00
LH3266(DGF1)	50.8	6 x 6	48.20	7.20	17.46	94.2	993.6/223361	1143.0	26.35
LH3288(DGF2)		8 x 8				124.5	1364.6/306774	1500.0	35.09
LH4066(DG)	63.5	6 x 6	60.33	9.91	23.81	131.2	1301.1/292487	1496.0	48.10
BL2088F2(DG)	63.5	8 x 8	58.20	9.70	23.81	170.0	1734.8/389983	1995.0	56.74
LL2466(DG)	38.1	6 x 6	33.40	5.00	14.63	67.4	510.0/114648	536.0	13.00
LL2844(DGF1)	44.45	4 x 4	36.00	6.00	15.90	54.7	400.0/89923	450.0	10.92
LL3266(DGF1)	50.8	6 x 6	42.00	6.40	17.81	86.0	780.0/175344	858.0	19.53
LL3288(DGF2)		8 x 8				112.0	1040.0/233792	1144.0	25.91
LL3244F2(DG)	50.8	4 x 4	43.10	6.00	17.76	55.0	520.1/116900	570.0	12.62
LL3266F3(DG)		6 x 6				79.9	780.0/178344	858.0	18.84
LL3244F6(DG)	50.8	4 x 4	42.00	6.00	17.81	57.5	520.0/116900	570.0	12.35
LL3266F6(DG)		6 x 6				81.7	780.0/175344	858.0	18.30
LL3288F6(DG)		8 x 8				106.0	1040.0/233792	1144.0	24.30
LL4066(DG)	63.5	6 x 6	52.70	8.00	22.89	106.5	1080.0/242793	1245.0	31.62
LL4088(DG)		8 x 8				140.0	1400.0/314733	1650.0	42.10
LL4088F2(DG)	63.5	8 x 8	52.70	8.20	22.89	140.0	1440.0/323725	1670.0	42.39



Fenner® Special Leaf Chains for Sky Stacker

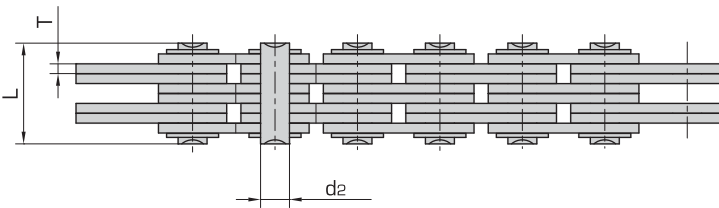
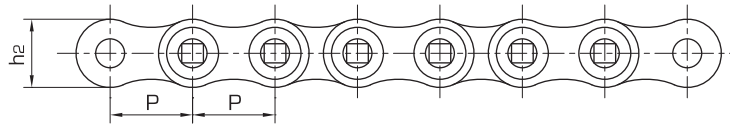
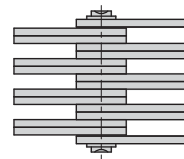
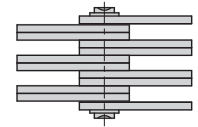
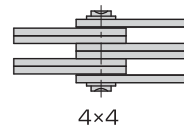

Plate lacing



Chain No.	Pitch	Plate lacing	Plate depth h_2 max mm	Plate thickness T max mm	Pin diameter d_2 max mm	Pin length L max mm	Ultimate tensile strength Q min kN/lbf	Average tensile strength Q_0 kN	Weight per meter q kg/m
	P mm								
LL3244(DG)		4 x 4				65.0	520.0/116895	598.0	13.73
LL3266(DG)	50.8	6 x 6	42.00	6.40	17.81	90.8	780.0/175344	897.0	19.94
LL3288(DG)		8 x 8				117.0	1040.0/233792	1196.0	26.10
LL4066F5(DG)	63.5	6 x 6	52.70	8.00	22.89	112.7	1080.0/242794	1245.0	32.59





Fenner® Multiple Plate Bearing Pin Chains

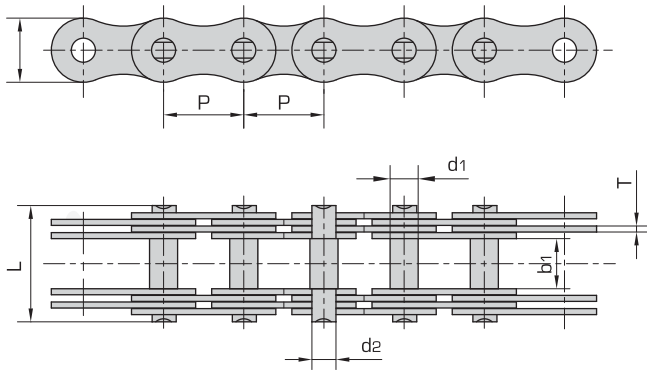
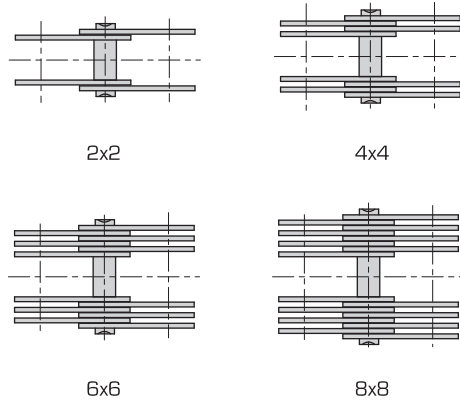

Plate lacing



Chain No.	Pitch P mm	Width between inner plates b2 min mm	Plate lacing	Pin diameter		Pin length L max mm	Plate depth h2 max mm	Plate thickness T max mm	Ultimate tensile strength Q0 kN	Weight per meter q kg/m
				d2 max mm	d3 max mm					
MP15	15	12	2 x 2	5	4	25	12	2.03	5.0/1125	0.7
MP20	20	15	2 x 2	8	6	28	15	2.03	12.5/2812	1.1
MP25	25	18	2 x 2	10	8	36	18	3.00	25.0/5624	1.8
MP30	30	20	4 x 4	11	9	51	20	3.00	40.0/8999	3.4
MP35	35	22	4 x 4	12	10	53	26	3.00	60.0/13498	4.5
MP40	40	25	4 x 4	14	12	58	32	3.00	80.0/17998	5.0
MP45	45	30	4 x 4	17	14	63	35	3.00	100.0/22497	7.0
MP50	50	35	4 x 4	22	18	90	40	4.50	150.0/33746	11.3
MP55	55	40	4 x 4	24	21	108	42	6.00	200.0/44994	14.5
MP60	60	45	4 x 4	26	23	114	46	6.00	250.0/56243	17.1
MP70	70	50	6 x 6	32	28	148	55	6.00	375.0/84364	34.0
MP80	80	60	6 x 6	36	32	159	60	6.00	500.0/112486	39.0
MP90	90	70	6 x 6	40	36	184	70	7.00	750.0/168728	53.0
MP100	100	80	8 x 8	45	40	224	80	7.00	1000.0/224972	77.0
MP110	110	90	8 x 8	50	45	236	90	7.00	1250.0/281215	90.0
MP120	120	100	8 x 8	55	50	262	100	8.00	1500.0/337458	112.0



Fenner® Multiple Plate Bearing Pin Chains

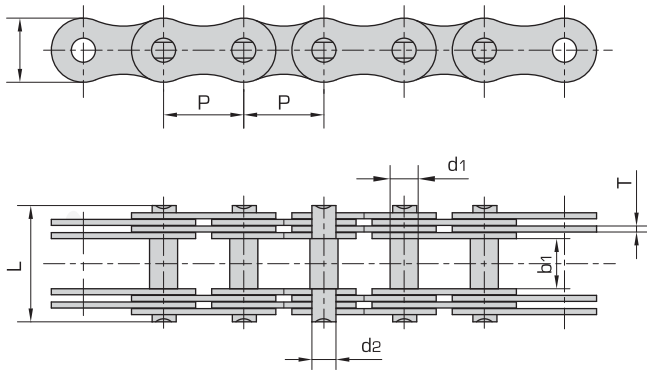
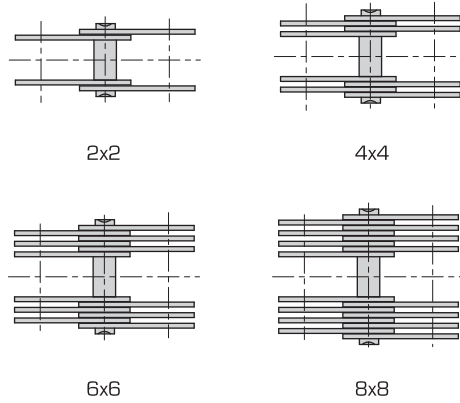

Plate lacing



Chain No.	Pitch P mm	Width between inner plates b ₂ min mm	Plate lacing	Pin diameter		Pin length L max mm	Plate depth h ₂ max mm	Plate thickness T max mm	Ultimate tensile strength Q ₀ kN	Weight per meter q kg/m
				d ₂ max mm	d ₃ max mm					
LF30	30.0	16.5	2 x 2	6.0	5.00	27.7	15.7	2.03	20.0/4496	0.72
MP50F2	50.0	38.0	6 x 6	22.0	18.00	85.0	40.0	3.00	250.0/56202	11.11
MP50.8	50.8	36.0	6 x 6	22.0	17.81	85.4	42.0	3.25	200.0/44961	11.90
MP70F1	70.0	21.0	2 x 2	16.5	14.00	51.5	30.5	6.00	145.0/32597	4.16
MP70F2	70.0	50.0	8 x 8	32.0	28.00	158.0	55.0	5.00	375.0/84303	44.00
MP70F3	70.0	52.0	8 x 8	32.0	28.00	160.0	55.0	5.00	375.0/84303	31.62
MP80F1	80.0	60.0	8 x 8	36.0	32.00	170.0	60.0	5.00	500.0/112404	35.32
*MP90F2	90.0	60.4	6 x 6	40.0	37.00	182.0	70.0	8.00	700.0/157366	52.70
*MP90F1	90.0	60.0	4 x 4	36.0	32.00	146.0	60.0	8.00	600.0/134885	32.22
*MP110F1	110.0	90.0	8 x 8	50.0	45.00	239.0	90.0	7.00	1250.0/281011	87.50

Note: * means straight link plate;



Fenner® Car Parking Chains

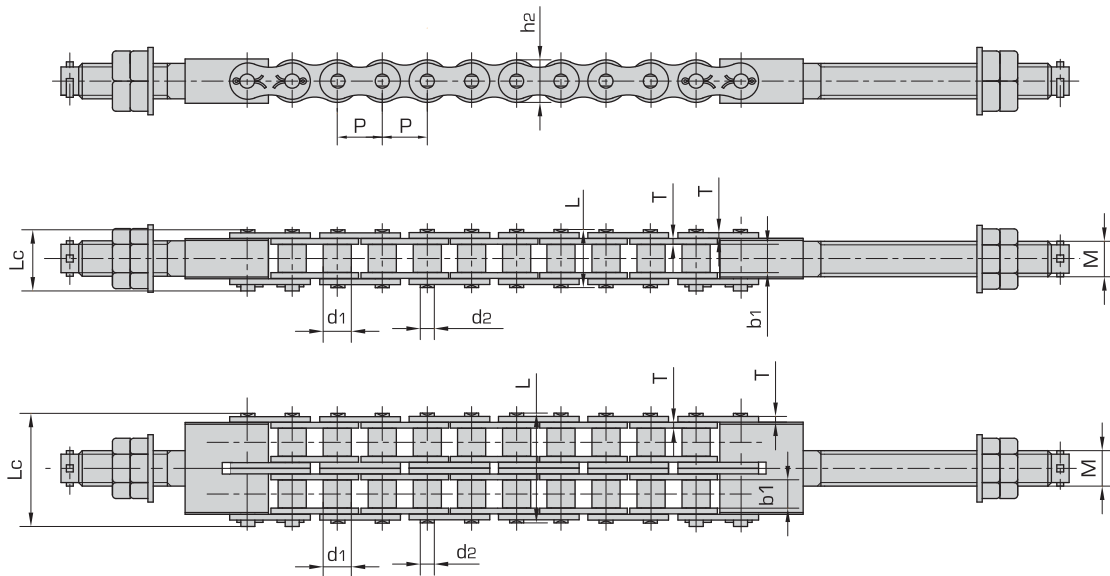

Chain No.	Pitch P mm	Roller diameter d1 max mm	Width between inner plates b1 min mm	Pin diameter d2 max mm	Pin length		Inner plate depth	Plate thickness T max mm	Bolt type	Ultimate tensile strength Q _{min} kN/lbf	Average tensile strength Q ₀ kN	Weight per meter q kg/m
					L max	Lc max						
16ALT-1	25.4	15.88	15.75	7.92	32.7	36.5	24.0	3.25	M20	71.55/16261	81.8	2.60
16ALT-2	25.4	15.88	7.92	62.7	65.8	24.0	24.0	3.25	M20	143.10/32523	166.3	5.15
20ALT-1	31.75	19.05	18.90	9.53	40.4	44.7	30.0	4.00	M24	107.85/24511	118.6	3.91
20ALT-2	31.75	19.05	18.90	9.53	76.4	80.5	30.0	4.00	M24	215.70/49023	234.4	7.80
20ALT-3	31.75	19.05	18.90	9.53	112.2	116.3	30.0	4.00	M24	323.55/73534	351.6	11.77
24ALT-1	38.1	22.23	25.22	11.10	50.3	54.3	35.7	4.80	M30	149.20/330909	161.1	5.62
24ALT-2	38.1	22.23	25.22	11.10	95.8	99.7	35.7	4.80	M30	298.40/67818	322.2	11.70



Fenner® Rollerless Hoisting Chains

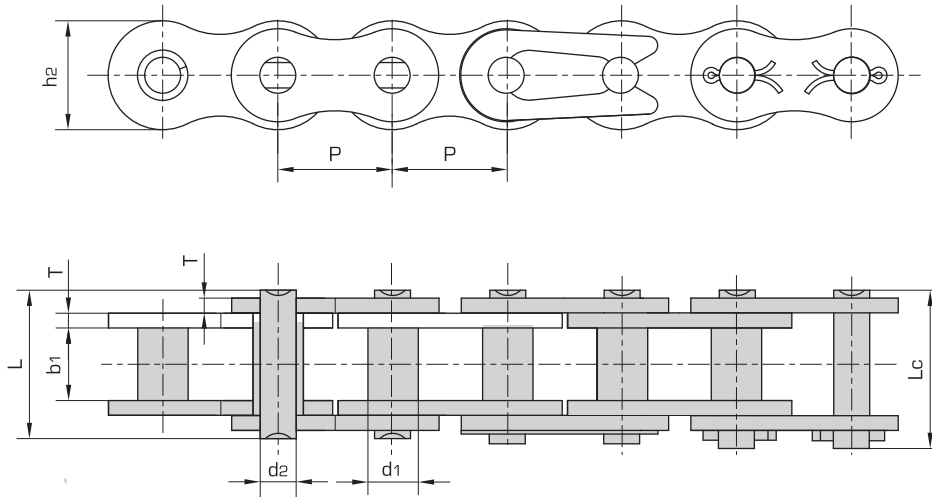

Chain No.	Pitch P mm	Roller diameter d1 max mm	Width between inner plates b1 min mm	Pin diameter d2 max mm	Pin length		Inner plate depth	Plate thickness T max mm	Ultimate tensile strength Q _{min} kN/lbf	Average tensile strength Q ₀ kN	Weight per meter q kg/m
					L max	Lc max					
45-1	12.7	5.63	7.85	3.96	16.6	17.8	12.00	1.50	14.10/3205	17.5	0.54
55-1	15.875	7.03	9.40	5.08	20.7	22.2	15.09	2.03	22.20/5045	29.4	0.83
65-1	19.05	8.33	12.57	5.94	25.9	27.7	18.00	2.42	31.80/7227	41.5	1.22
85-1	25.4	11.10	15.75	7.92	32.7	35.0	24.00	3.25	56.70/12886	69.5	2.16
105-1	31.75	13.60	18.90	9.53	40.4	44.7	30.00	4.00	88.50/20114	109.2	3.31
125-1	38.1	15.60	25.22	11.10	50.3	54.3	35.70	4.80	127.00/28864	156.3	4.97
145-1	44.45	18.00	25.22	12.70	54.4	59.0	41.00	5.60	172.40/39182	212.0	6.50
165-1	50.8	20.00	31.55	14.27	64.8	69.6	47.80	6.40	226.80/51545	278.9	8.70



Fenner® Special Leaf Chains with Plastic Guides

Leaf chains with externally positioned plastic tube guides are generally used in forklifts as load chains. The plastic link plates are usually mounted on the outside of the pins and have following effect: When the unavoidable vibration or jamming of the chain occurs, the chain links will not hit the piston rod of the hydraulic cylinder, but the protruding plastic link plates. This means that neither chain or cylinder are damaged. The plastic coverings are also available as inside-positioned, T, U or L formed coverings.

Advantages of the technically enhanced leaf chains

- Higher fatigue strength due to optimized press fit pin and outer link plates
- Higher tensile strength due to optimized plate strength
- Higher wear resistance due to higher surface hardness of the pins (> 52 HRC)
- Enhanced emergency running properties due to ground pin surfaces and special lubricants
- High fitting accuracy due to limiting the tolerances when using cold rolled strips for all link plates
- Higher reliability by AVIS (Automatic Visual Inspection) for securing the full link plate number and arrangement as well as controlling the link plate thickness

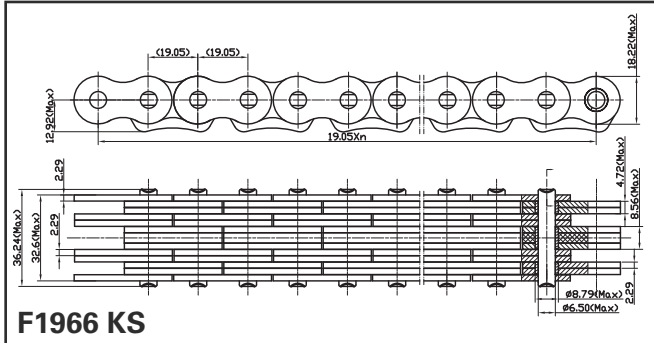
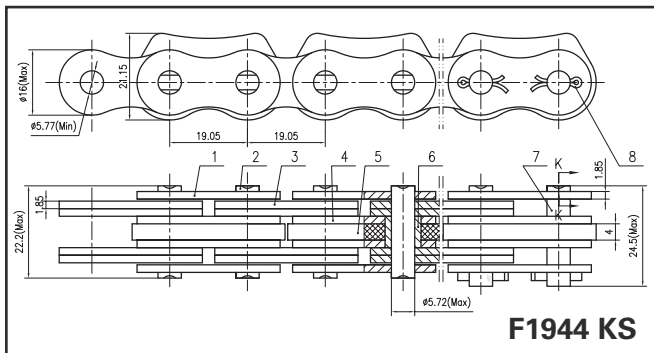
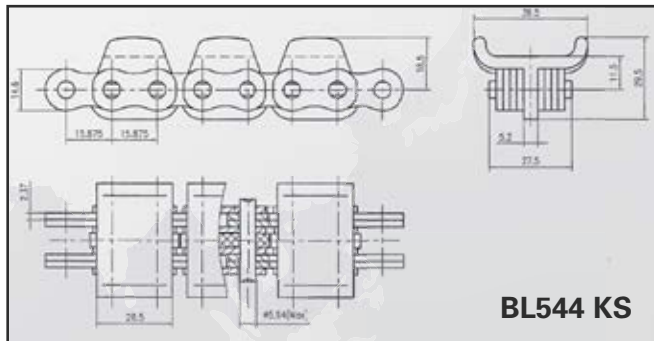



Fenner® Special Leaf Chains with Plastic Guides

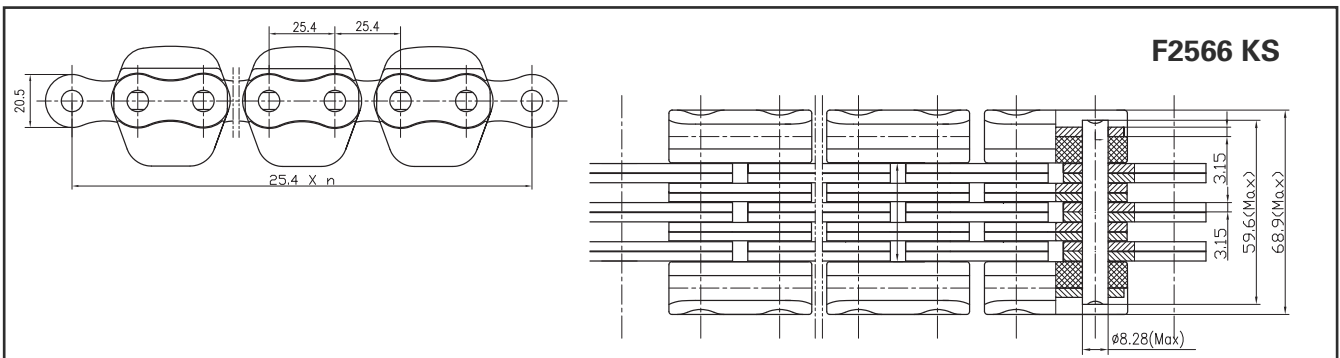
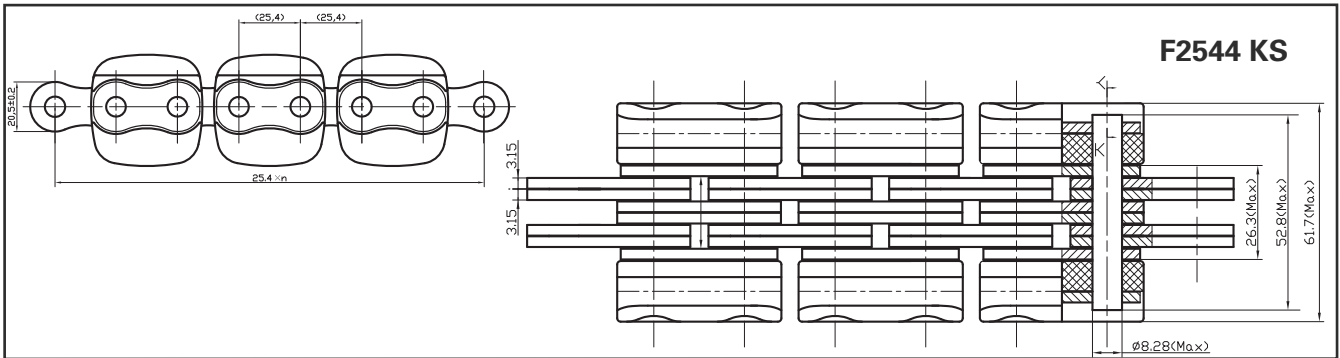
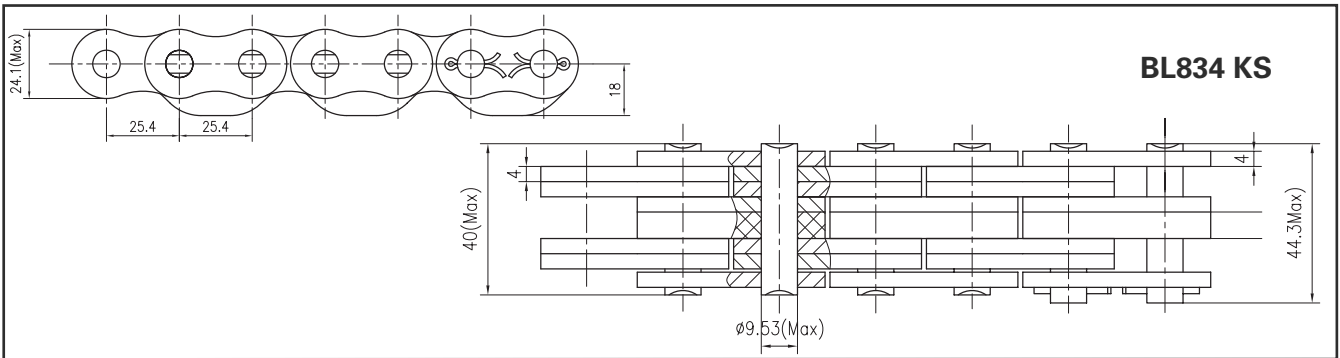
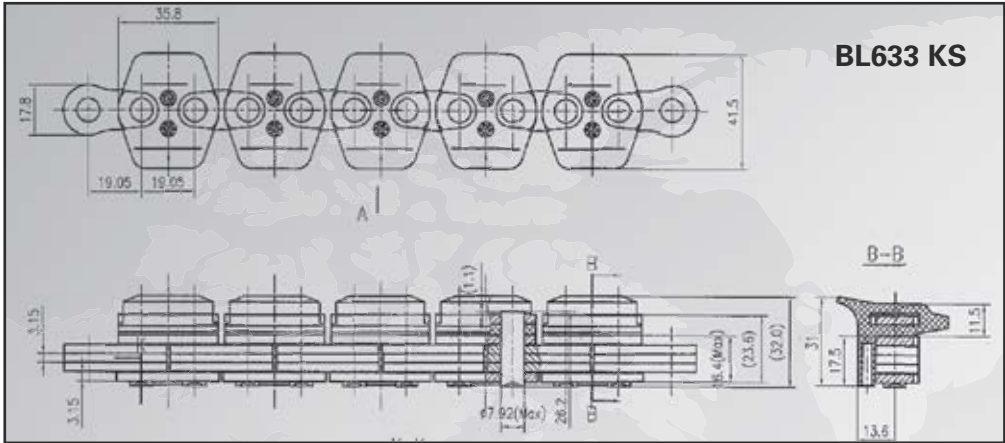



Fenner® Special Leaf Chains with Plastic Guides

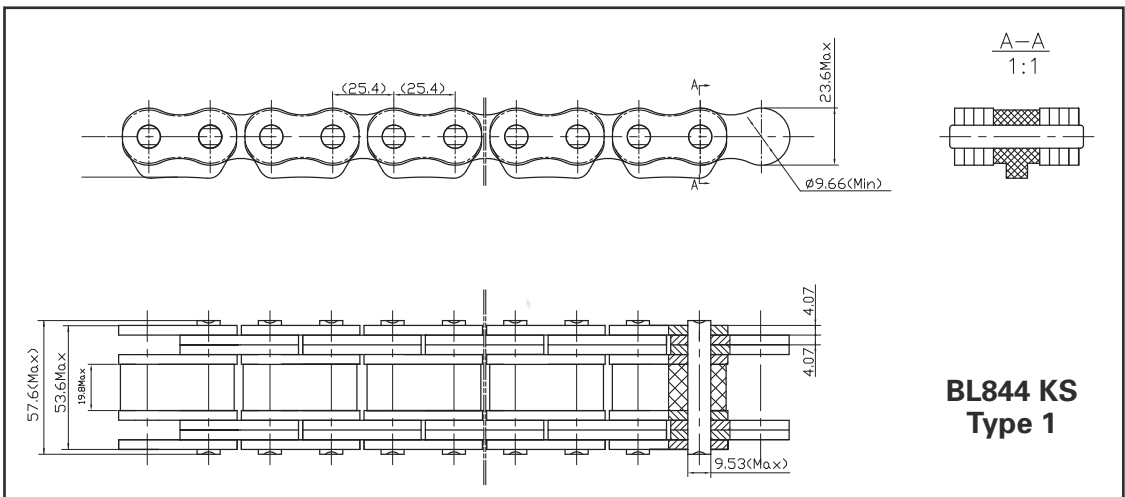
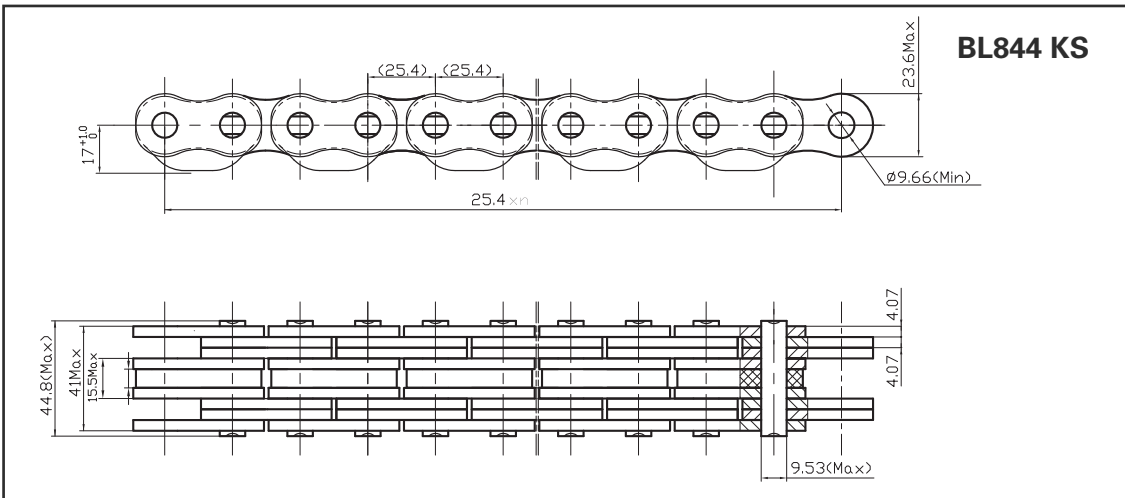
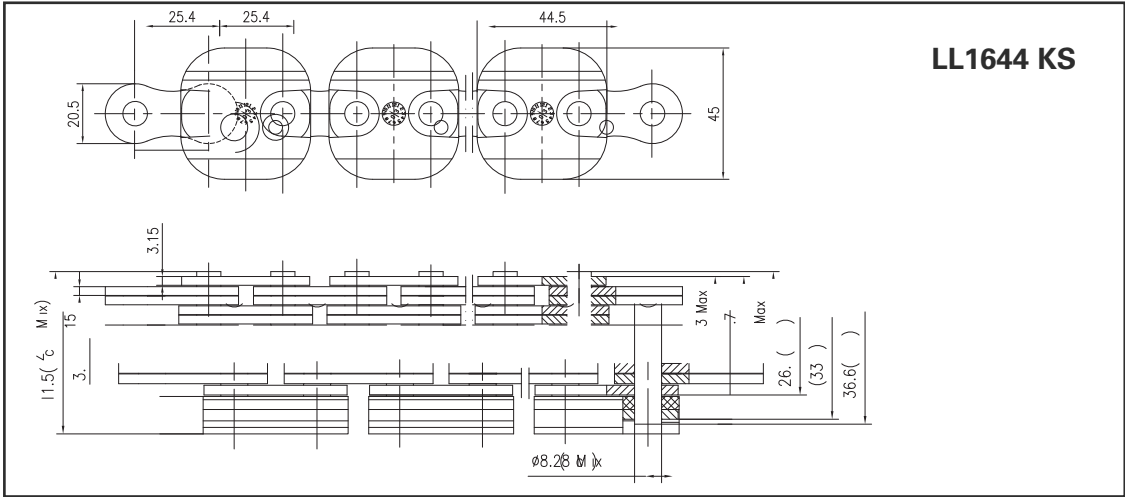



Fenner® Special Leaf Chains with Plastic Guides

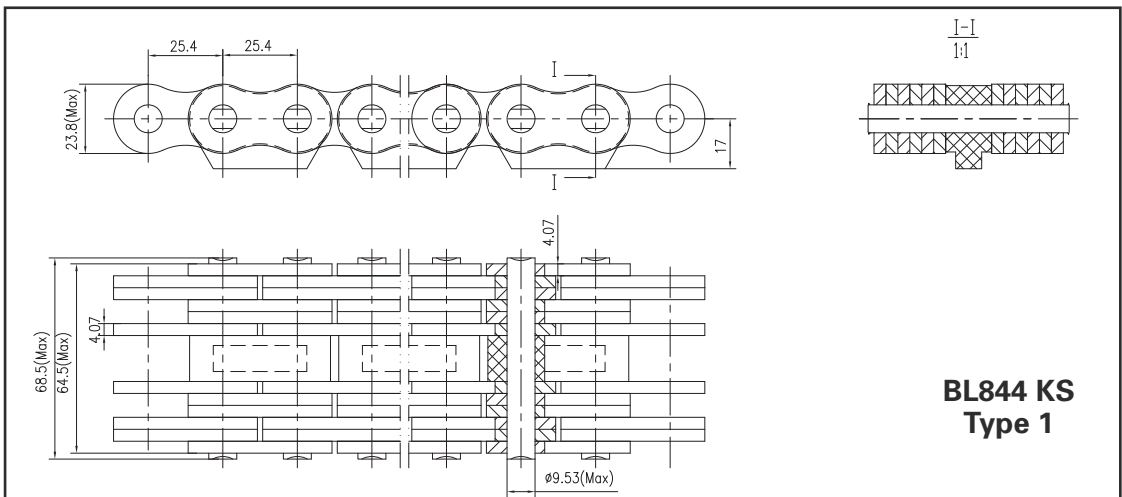
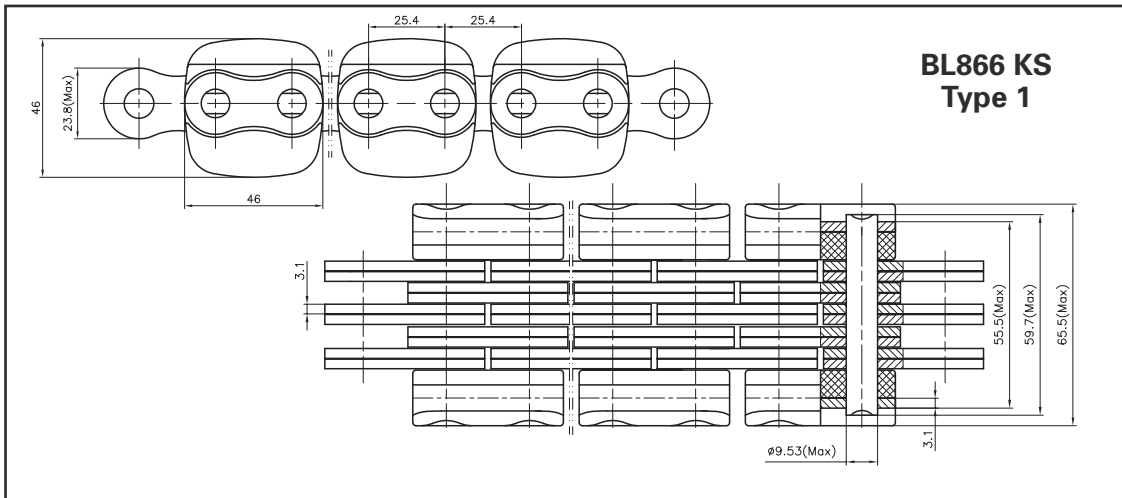
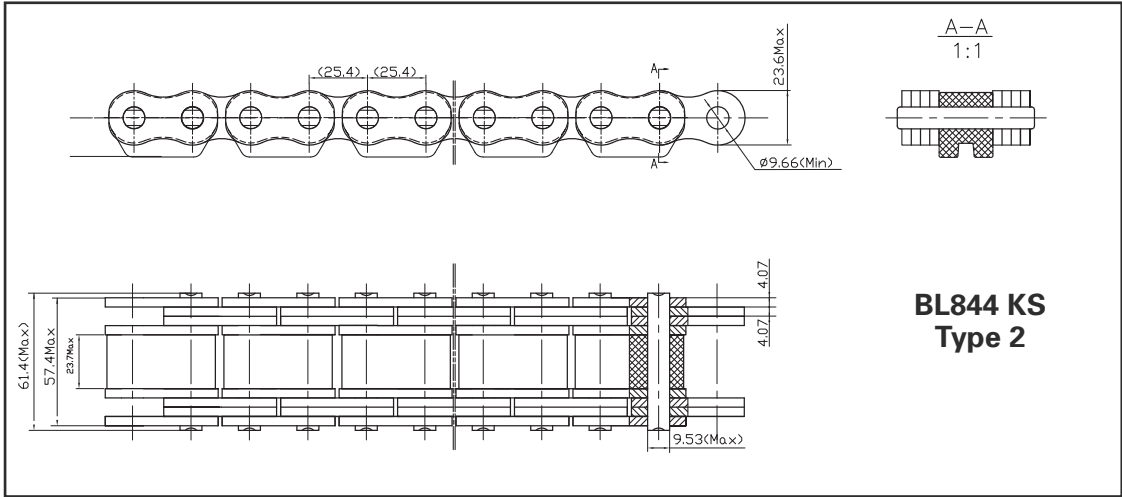



Fenner® Special Leaf Chains with Plastic Guides

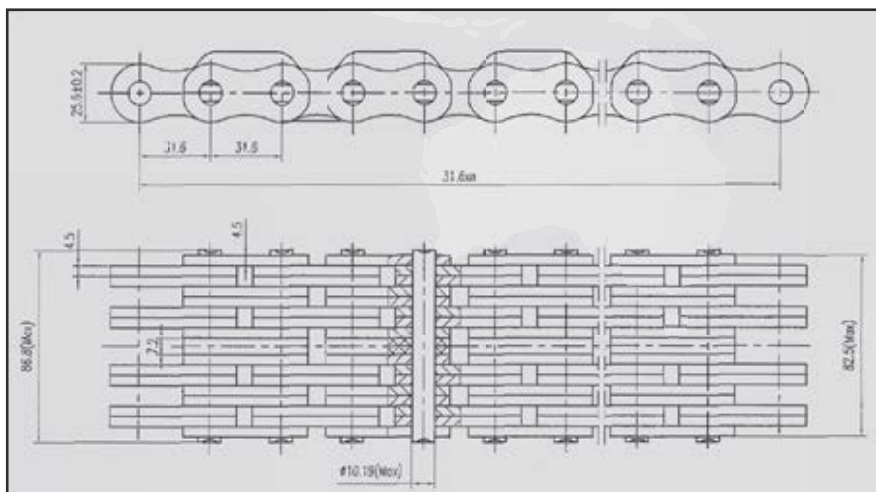
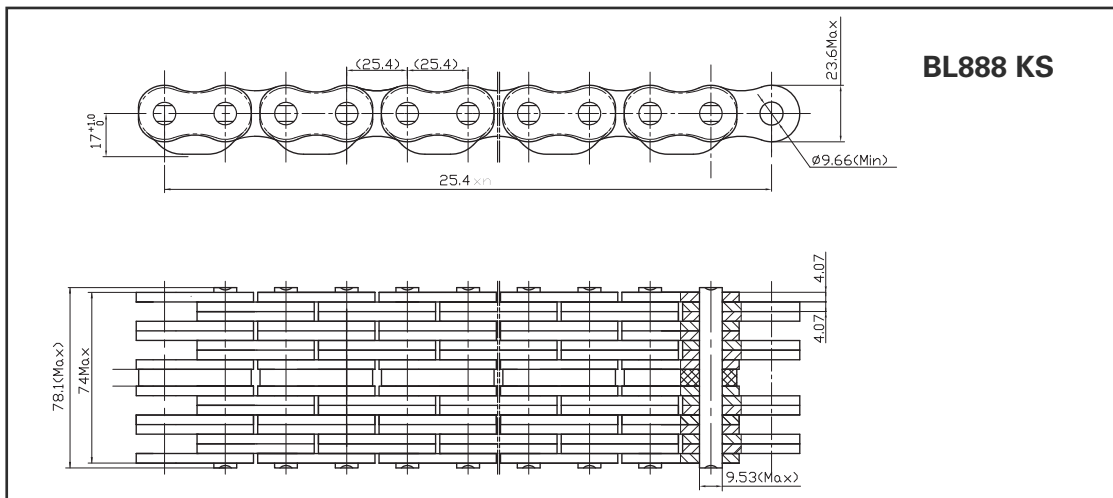
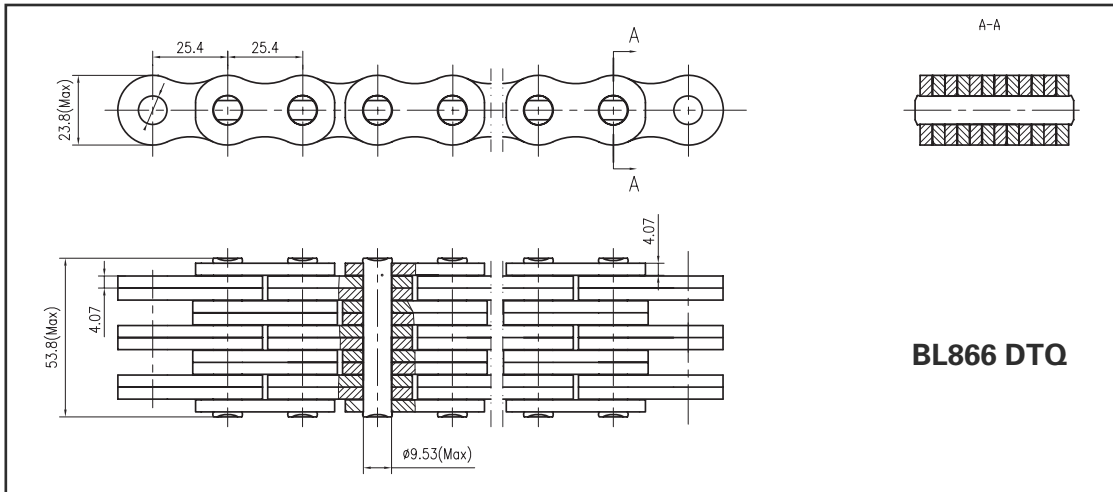



Fenner® Connecting Pins for Leaf Chains

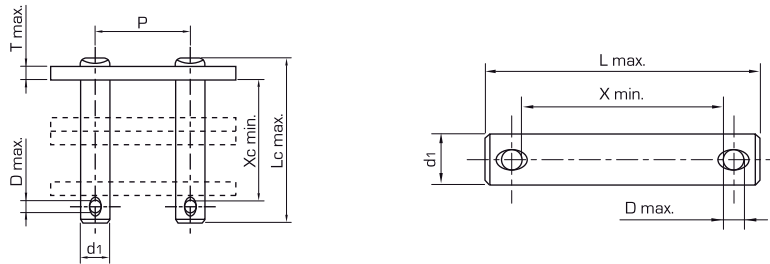

Chain No.	Connecting Link					Connecting Pin		Pin diameter d1 max mm	Hole diameter D max mm
	Pitch P mm	Plate lacing Outer x Inner	Plate depth h max mm	Plate thickness T max mm	Pin length Lc max mm	Pin length L max mm	Width between holes X min mm		
LL0822	12.7	2x2	10.60	1.6	*10.75	13.50	6.75	4.45	1.6
LL0844		4x4			*	20.10	13.32		
LL0866		6x6			*	26.60	19.79		
LL0888		8x8			*	33.00	26.15		
LL1022	15.875	2x2	13.70	1.6	*	13.50	6.75	5.08	1.6
LL1044		4x4			*17.6	21.10	15.00		
LL1066		6x6			*23.9	28.50	22.20		
LL1088		8x8			*30.5	34.15	28.00		
LL1222	19.05	2x2	16.00	1.9	*12.5	13.95	7.70	5.72	1.60
LL1244		4x4			*19.9	25.50	17.60		
LL1266		6x6			*27.55	32.70	24.70		
LL1288		8x8			*35	40.00	30.00		
LL1622	25.4	2x2	21.00	3.1	*	22.90	12.82	8.28	2.50
LL1644		4x4			*31.5	36.10	25.99		
LL1666		6x6			*	49.00	38.89		
LL1688		8x8			*57.65	60.80	50.95		
LL2022	31.75	2x2	26.40	3.5	*22.9	30.30	19.50	10.19	3.20
LL2044		4x4			*37.35	43.70	33.00		
LL2066		6x6			*52.3	57.70	47.00		
LL2088		8x8			*67.5	72.70	62.00		
LL2422	38.1	2x2	33.40	5.0	*	34.05	21.75	14.63	4.00
LL2444		4x4			*50.85	56.35	43.20		
LL2466		6x6			*70.85	77.75	64.50		
LL2488		8x8			*91.3	99.15	86.00		
LL2822	44.45	2x2	37.08	6.0	*	39.45	26.25	15.90	4.00
LL2844		4x4			*61.35	65.25	52.05		
LL2866		6x6			*85.55	91.05	77.85		
LL2888		8x8			*	116.45	103.65		
LL3222	50.8	2x2	42.00	6.4	*	43.65	26.25	17.81	5.00
LL3244		4x4			*65.25	77.50	59.90		
LL3266		6x6			*91.7	104.00	86.40		
LL3288		8x8			*117.3	131.50	113.90		
LL4022	63.5	2x2	52.76	8.0	*	54.60	34.50	22.89	6.30
LL4044		4x4			*79.55	92.00	72.00		
LL4066		6x6			*112.2	122.60	102.50		
LL4088		8x8			*144.6	156.60	136.50		
LL4822	76.2	2x2	63.88	10.0	*	145.80	125.00	29.24	5.00
LL4844		4x4			*				
LL4866		6x6			*				
LL4888		8x8			*				

* The exact value within tolerances. ** X min



Fenner® Connecting Pins for Leaf Chains

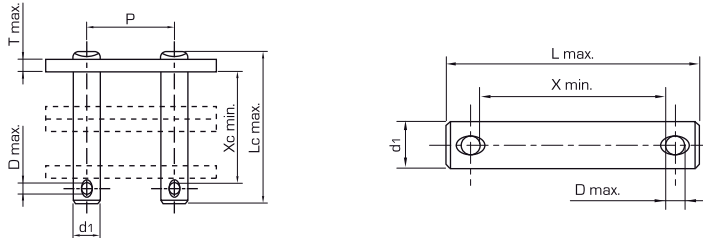

Chain No.	Connecting Link					Connecting Pin		Pin diameter d1 max mm	Hole diameter D max mm
	Pitch P mm	Plate lacing Outer x Inner	Plate depth h max mm	Plate thickness T max mm	Pin length Lc max mm	Pin length L max mm	Width between holes X min mm		
BL422	12.7	2x2	12.07	2.08	*15.3	17.00	11.00	5.08	1.6
BL423		2x3			*	18.90	12.70		
BL434		3x4			*19.35	23.20	17.00		
BL444		4x4			*21.15	25.20	19.00		
BL446		4x6			*25.3				
BL466		6x6			*	33.30	27.00		
BL488		8x8			*				
BL522	15.875	2x2	15.09	2.44	*	19.40	12.80	5.94	2.0
BL523		2x3			*17.95	21.60	15.00		
BL534		3x4			*22.75	26.60	20.00		
BL544		4x4			*25	29.10	22.29		
BL546		4x6			*30	33.70	26.79		
BL566		6x6			*34.8	39.00	31.75		
BL588		8x8			*44.9	49.30	42.25		
BL622	19.05	2x2	18.11	3.30	*	25.00	14.20	7.92	3.2
BL623		2x3			*21.95	30.70	20.00		
BL634		3x4			*28.95	37.70	26.75		
BL644		4x4			*32.95	40.70	29.75		
BL646		4x6			*39.85	47.70	36.75		
BL666		6x6			*45.82	53.70	42.75		
BL688		8x8			*	67.20	56.25		
BL822	25.4	2x2	24.13	4.09	*	28.66	17.51	9.53	3.2
BL823		2x3			*28.25	35.70	25.00		
BL834		3x4			*36.75	43.90	32.95		
BL844		4x4			*	47.70	37.00		
BL846		4x6			*48.15	56.70	46.00		
BL866		6x6			*56.75	63.70	53.00		
BL888		8x8			*	80.30	69.50		
BL1022	31.75	2x2	30.18	4.90	*	31.90	19.50	11.11	4.0
BL1023		2x3			*33.55	42.50	30.00		
BL1034		3x4			*	51.60	39.20		
BL1044		4x4			*48.1	56.60	43.95		
BL1046		4x6			*57.55	66.60	54.20		
BL1066		6x6			*67.35	75.60	62.90		
BL1088		8x8			*	92.40	79.90		
BL1222	38.1	2x2	36.2	5.77	*	37.60	23.60	12.70	4.0
BL1223		2x3			*	43.20	29.30		
BL1234		3x4			*50.2	58.60	46.20		
BL1244		4x4			*55.75	64.00	49.70		
BL1246		4x6			*66.95	76.00	63.20		
BL1266		6x6			*78.35	87.80	75.00		
BL1288		8x8			*	111.00	98.25		

* The exact value within tolerances. ** X min



Fenner® Connecting Pins for Leaf Chains

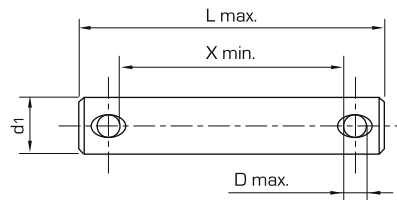
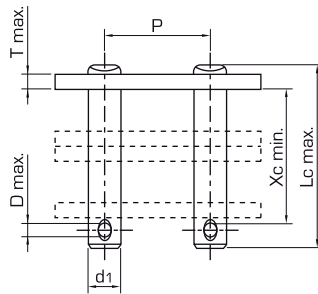

Chain No.	Connecting Link					Connecting Pin		Pin diameter d1 max mm	Hole diameter D max mm
	Pitch P mm	Plate lacing Outer x Inner	Plate depth h max mm	Plate thickness T max mm	Pin length Lc max mm	Pin length L max mm	Width between holes X min mm		
BL1422		2x2			*				
BL1423		2x3			*				
BL1434		3x4			*56,2	64.60	52.20		
BL1444	44.45	4x4	42.24	6.55	*			14.27	4.0
BL1446		4x6			*75.55	84.20	71.70		
BL1466		6x6			*	92.40	78.40		
BL1488		8x8			*				
BL1622		2x2			*	47.80	29.40		
BL1623		2x3			*49,1	60.60	53.10		
BL1634		3x4			*	70.20	52.80		
BL1644	50.80	4x4	48.26	7.52	*70.95	82.90	65.70	17.46	5.0
BL1646		4x6			*85.8	97.40	79.90		
BL1666		6x6			*99.85	112.20	94.60		
BL1688		8x8			*	135.50	116.60		
BL2022		2x2			*				
BL2023		2x3			*				
BL2034		3x4			*				
BL2044	63.50	4x4	60.33	9.91	*			23.6	5.0
BL2046		4x6			*				
BL2066		6x6			*	141.30	119.90		
BL2088		8x8			*				

* The exact value within tolerances. ** X min



Fenner® Connecting Pins for Leaf Chains

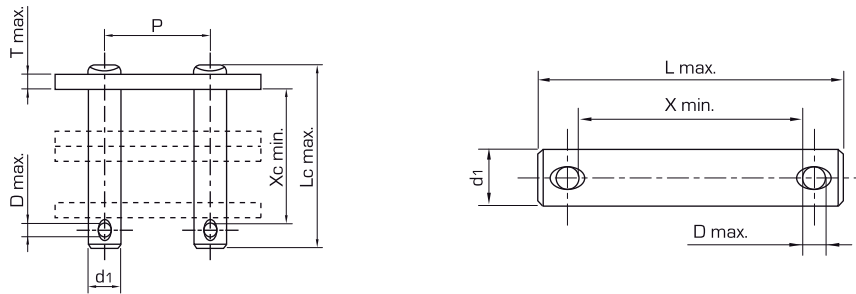

Chain No.	Connecting Link					Connecting Pin		Pin diameter d1 max mm	Hole diameter D max mm
	Pitch P mm	Plate lacing Outer x Inner	Plate depth h max mm	Plate thickness T max mm	Pin length Lc max mm	Pin length L max mm	Width between holes X min mm		
AL0322	9.525	2X2	7.70	1.30	*	11.80	6.65	3.58	1.2
AL0344		4X4			*13.25	16.60	11.42		
AL0422	12.7	2X2	10.40	1.50	*10.45	12.75	6.50	3.96	1.6
AL0444		4X4			*16.7	19.35	12.90		
AL0466		6X6			*22.75	25.95	19.30		
AL0522	15.875	2X2	12.80	2.03	*12.9	17.00	11.00	5.08	1.6
AL0523		2x3			*15.25	18.90	12.70		
AL0534		3X4			*19.25	23.20	17.00		
AL0544		4X4			*21.25	25.20	19.00		
AL0566		6X6			*29.25	33.30	27.00		
AL0622	19.05	2X2	15.60	2.42	*15.5	19.40	12.80	5.94	2.0
AL0623		2x3			*17.75	21.60	15.00		
AL0644		4X4			*25.2	29.10	22.29		
AL0666		6X6			*34.25	39.00	31.75		
AL0688		8X8			*44.65	49.30	42.25		
AL0822	25.4	2X2	20.50	3.25	*18.9	25.00	14.20	7.92	3.2
AL0844		4X4			*22.95	40.70	29.75		
AL0866		6x6			*45.6	53.70	42.75		
AL0888		8x8			*58.65	67.20	56.25		
AL1022	31.75	2X2	25.60	4.00	*24.1	28.66	17.61	9.53	3.2
AL1044		4X4			*40.75	47.70	37.00		
AL1066		6X6			*56.65	63.70	53.00		
AL1088		8X8			*72.2	80.30	69.40		
AL1222	38.1	2X2	30.50	4.80	*	31.90	19.50	11.10	3.2
AL1244		4X4			*48.2	56.60	43.95		
AL1266		6X6			*67.39	75.60	62.90		
AL1288		8X8			*	92.40	79.90		
AL1444	44.45	4X4	36.40	5.60	*	59.90	45.70	12.70	4.0
AL1466		6X6			*	82.90	68.40		
AL1644	50.8	4X4	41.60	6.40	*62.65	71.05	58.60	14.21	4.0
AL1666		6X6			*	93.20	77.70		
AL1688		8X8			*	118.70	103.35		

* The exact value within tolerances. ** X min



Fenner® Plate Lacing

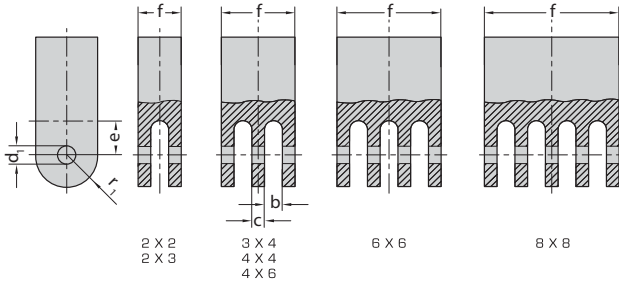

Measurements for Anchors Mounted on Inner Plates

Chain No.	f max. mm	b min. mm	c max. mm	d ₁ D 10 mm	e min. mm	r _t max. mm	r ₂ max. mm
BL422/AL522	10.7	4.2	-				2.0
BL423	12.6	6.4	-				3.0
BL434	16.9	4.2	2.0				2.0
BL444/AL544	18.9	4.2	4.0	5.1	9.0	6.5	2.0
BL446	22.9	6.4	4.0				3.0
BL466/AL566	26.9	4.2	4.0				2.0
BL488/AL588	35.4	4.2	4.0				2.0
BL522	12.7	5.0	-				2.0
BL523	14.9	7.5	-				3.0
BL534	19.9	5.0	2.4				2.0
BL544/AL644	22.4	5.0	4.8	6.0	11.0	8.0	2.0
BL546	26.9	7.5	4.8				3.0
BL566/AL666	31.9	5.0	4.8				2.0
BL588/AL688	42.4	5.0	4.8				2.0
BL623	19.9	10.3	-				5.0
BL634	26.9	6.8	3.2				3.0
BL644/AL844	29.9	6.8	6.4	8.0	14.0	9.5	3.0
BL646	36.9	10.3	6.4				5.0
BL666/AL866	42.9	6.8	6.4				3.0
BL688/AL888	56.4	6.8	6.4				3.0
BL823	24.9	12.8	-				6.0
BL834	32.9	8.5	4.0				4.0
BL844/AL1044	36.9	8.5	8.0	9.6	18.0	12.5	4.0
BL846	45.9	12.8	8.0				6.0
BL866/AL1066	52.9	8.5	8.0				4.0
BL888/AL1088	69.4	8.5	8.0				4.0
BL1023	29.8	15.1	-				7.0
BL1034	39.0	10.0	4.7				5.0
BL1044/AL1244	44.0	10.0	9.4	11.2	22.0	15.0	5.0
BL1046	54.0	15.1	9.4				7.0
BL1066/AL1266	63.0	10.0	9.4				5.0
BL1088/AL1288	79.7	10.0	9.4				5.0
BL1223	34.3	17.7	-				8.0
BL1234	46.0	11.8	5.5				5.0
BL1244/AL1444	49.0	11.8	11.0	12.8	26.0	19.0	5.0
BL1246	63.3	17.7	11.0				8.0
BL1266/AL1466	75.1	11.8	11.0				5.0
BL1288/AL1488	98.4	11.8	11.0				5.0
BL1423	38.5	20.1	-				10.0
BL1434	52.0	13.4	6.3				6.0
BL1444	58.4	13.4	12.6	14.3	31.0	22.0	10.0
BL1446	71.5	20.1	12.6				10.0
BL1466	84.9	13.4	12.6				10.0
BL1623	42.8	22.5	-				10.0
BL1634	57.7	15.0	7.1				7.0
BL1644	65.4	15.0	14.2	17.5	34.0	25.0	7.0
BL1646	79.6	22.5	14.2				10.0
BL1666	94.3	15.0	14.2				7.0
BL1688	123.7	15.0	14.2				7.0

Chain No.	f max. mm	b min. mm	c max. mm	d ₁ D 10 mm	e min. mm	r _t max. mm	r ₂ max. mm
LL0844	15.9						
LL0866	22.9	3.7	3.4	4.5	7.0	6.5	1.7
LL1044	14.9						
LL1066	21.9	3.5	3.0	5.1	8.5	8.0	1.7
LL1644	27.9						
LL1666	40.9	6.7	6.2	8.3	13.5	13.0	3.0
LL1688	53.9						
LL2044	32.9						
LL2066	46.9	7.5	7.0	10.2	17.0	16.5	3.5
LL2088	61.9						
LL2444	48.0						
LL2466	69.0	11.0	10.0	14.7	22.0	20.0	5.0
LL2488	90.9						
LL2822	29.5						
LL2844	54.8						
LL2866	80.0	13.0	12.0	16.0	25.0	24.0	6.0
LL2888	105.8						
LL3222	34.2						
LL3244	59.7						
LL3266	86.2	13.6	12.6	17.9	28.0	27.0	6.0
LL3288	113.7						
LL4022	39.6						
LL4044	73.0						
LL4066	106.3	17.0	16.0	23.0	35.0	35.0	8.0
LL4088	139.8						
LL4844	91.2						
LL4866	133.2	21.0	20.0	29.3	45.0	40.0	10.0
LL4888	173.9						
F19V-44	22.9	5.2	4.7	6.6	10.0	10.5	2.0
F19V-66	32.9						



Fenner® Connecting Plates for Leaf Chains

End Plates for inner links

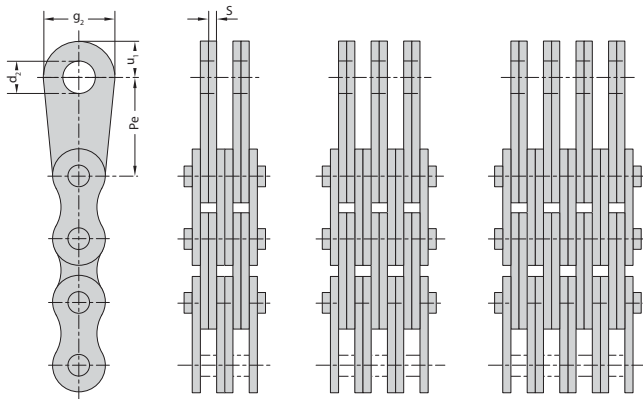

End Plates for outer links

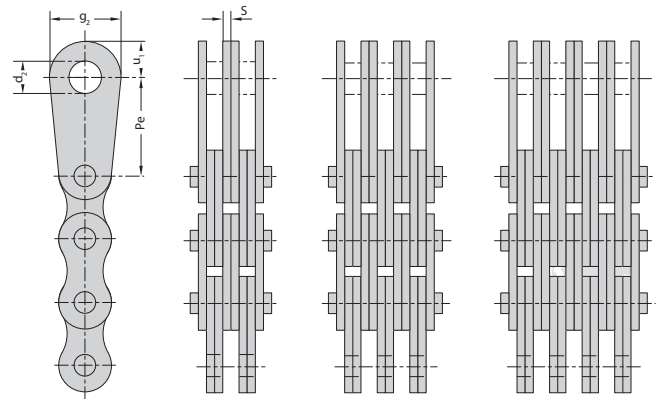

Chain No.	Pe mm	d ₂ A11 mm	g ₂ mm	s mm	u ₁ mm
LL0844 LL0866	15	6	16.0	1.7	10.0
LL1044 LL1066	20	8	18.0	1.5	11.0
LL1644 LL1666 LL1688	30	12	25.0	3.0	15.0
LL2044 LL2066 LL2088	50	18	40.0	3.5	25.0
LL2444 LL2466 LL2488	65	24	50.0	5.0	29.0
LL2822 LL2844 LL2866 LL2888	80	28	60.0	6.0	32.0
LL3222 LL3244 LL3266 LL3288	90	32	70.0	6.3	43.0
LL4022 LL4044 LL4066 LL4088	100	38	80.0	8.0	46.5
AL644 AL666 AL688	25	10	19.8	2.4	11.2
AL1044 AL1066	40	14	30.0	4.0	18.0
F19V44 F19V66	25	10	19.8	2.35	11.2

Our Presence in Asia Pacific



Fenner® products conform to international standards, as such, we can advise that all Fenner® products comply with appropriate national and international standards in terms of design, performance and safety / environmental requirements. Where appropriate international standards (ISO) exist, these take priority over national standards. In respect of some operational safety and environmental requirements, some European standards (EN) are considered definitive worldwide.

FPT FAR EAST



FPT Far East Pte. Ltd

29 Changi South Avenue 2 #04-00, ABV Building, Singapore 486444

(65) 6545 6630 📞 (65) 6545 7730 / 7720 ✉ sales@fpt.com.sg

🌐 @fennerSEA 🌐 @fennerseasia 🌐 @fptfareast

🌐 www.fpt.com.sg 🌐 gpcasiapac.com 🌐 inencogroup.com.au